

# USER'S GUIDE

Réplicateur de port avancé Dell™ Latitude™ L400 –

## GUIDE DE L'UTILISATEUR

Dell™ Latitude™ L400 Advanced Port Replicator –

## GUIA DO USUÁRIO

Replicador de puertos avanzado (APR) para sistemas Dell™ Latitude™ L400 –

## GUÍA DEL USUARIO



Dell™ Latitude™ L400 Advanced Port Replicator

# USER'S GUIDE

[www.dell.com](http://www.dell.com)  
[support.dell.com](http://support.dell.com)



## ***Notes, Notices, and Cautions***

Throughout this guide, blocks of text may be accompanied by an icon and printed in bold type or in italic type. These blocks are notes, notices, and cautions, and they are used as follows:



*NOTE: A NOTE indicates important information that helps you make better use of your computer system.*

**NOTICE: A NOTICE indicates either potential damage to hardware or loss of data and tells you how to avoid the problem.**



**CAUTION: A CAUTION indicates the potential for bodily harm and tells you how to avoid the problem.**

---

**Information in this document is subject to change without notice.  
© 1999–2001 Dell Computer Corporation. All rights reserved.**

Reproduction in any manner whatsoever without the written permission of Dell Computer Corporation is strictly forbidden.

Trademarks used in this text: *Dell*, the *DELL* logo, *Latitude*, and *DellWare* are trademarks of Dell Computer Corporation.

Other trademarks and trade names may be used in this document to refer to either the entities claiming the marks and names or their products. Dell disclaims any proprietary interest in trademarks and trade names other than its own.

January 2001 P/N 2C982 Rev. A00



# **Dell™ Latitude™ L400**

## **Advanced Port Replicator**

### **User's Guide**

The Dell Latitude L400 Advanced Port Replicator (APR) integrates your Dell Latitude L400 computer quickly and easily into a desktop environment. Use the instructions in this document to attach external devices to the APR and to connect your computer to the APR.

## ***Safety Instructions***

Use the following safety guidelines to help protect your APR from potential damage and to help ensure your own personal safety:

- Do not attempt to service the APR yourself. Always follow installation instructions closely.
- Be sure that nothing rests on your AC adapter's power cable and that the cable is not located where it can be tripped over or stepped on.
- Place the AC adapter in a ventilated area, such as a desk top or on the floor, when powering the APR. Do not cover the AC adapter with papers or other items that will reduce cooling. Do not use the AC adapter inside a carrying case.
- Do not use your APR in a wet environment, for example, near a bathtub, sink, or swimming pool or in a wet basement.
- Do not push objects into air vents or openings of your APR. Doing so can cause fire or electric shock by shorting out interior components.
- Use only the AC adapter that is approved for use with this APR as indicated in this document. Use of another type of AC adapter may risk fire or explosion.
- Before you connect the APR to a power source, ensure that the voltage rating of the AC adapter matches that of the available power source:
  - 115 volts (V)/60 hertz (Hz) in most of North and South America and some Far Eastern countries such as South Korea and Taiwan

- 100 V/50 Hz in eastern Japan and 100 V/60 Hz in western Japan
- 230 V/50 Hz in most of Europe, the Middle East and the Far East
- To help prevent electric shock, plug the AC adapter and peripheral power cables into properly grounded power sources. These cables are equipped with three-prong plugs to help ensure proper grounding. Do not use adapter plugs or remove the grounding prong from a cable. If you must use an extension cable, use a three-wire cable with properly grounded plugs.
- If you use an extension cable with your AC adapter, ensure that the total ampere rating of the products plugged into the extension cable does not exceed the ampere rating of the extension cable.
- To remove power from the APR, turn off the computer and disconnect the AC adapter from the electrical outlet.
- If your computer includes an integrated or optional (PC Card) modem, the cable used with the modem should be manufactured with a minimum wire size of 26 American wire gauge (AWG) and an FCC-compliant RJ-11 modular plug.
- Disconnect the modem cable during an electrical storm to avoid the remote risk of electric shock from lightning via the telephone line.
- To help avoid the potential hazard of electric shock, do not connect or disconnect any cables or perform maintenance or reconfiguration of this product during an electrical storm.
- When setting up the APR for work, place it on a level surface.
- Protect your APR from environmental hazards such as dirt, dust, food, liquids, temperature extremes, and overexposure to sunlight.
- When you move your APR between environments with very different temperature or humidity ranges, condensation may form on or within the computer. To avoid damaging the APR, allow sufficient time for the moisture to evaporate before using the computer.

**NOTICE: When taking the APR from low-temperature conditions into a warmer environment or from high-temperature conditions into a cooler environment, allow the APR to acclimate to room temperature before turning on power.**













- When you disconnect a cable, pull on its connector or on its strain-relief loop, not on the cable itself. As you pull out the connector, keep it evenly aligned to avoid bending any connector pins. Also, before you connect a cable make sure both connectors are correctly oriented and aligned.
- Handle the APR with care.
- Before you clean your APR, shut down the computer and disconnect it from the APR. Then unplug the APR from its power source.
- Clean your APR with a soft cloth dampened with water rather than with liquid or aerosol cleaners.

- If your APR or computer gets wet or is damaged, follow the procedures described in "Troubleshooting Your Computer," in the *User's Guide*. If, after following these procedures, you confirm that your APR or computer is not operating properly, contact Dell. (See "Getting Help," in the *User's Guide* for the appropriate telephone number.)

## Connecting External Devices to the APR

The input/output (I/O) connectors on the back of the APR duplicate the primary connectors on the back and side of your computer. Table 1-1 shows the icons for each of the connectors on the back of the APR and indicates the type of external device(s) that can be attached to each connector.

**Table 1-1. External Connectors**

	The AC adapter that came with the APR connects to the AC adapter connector.
	A serial device, such as a serial mouse, connects to the serial connector.
	A microphone connects to the microphone connector.
	A speaker or headphones connect to the line-out connector.
	A network interface cable connects to the NIC connector.
	A USB device, such as a USB mouse, connects to the USB connector.
	An external phone line connects to the modem connector.
	An external monitor connects to the monitor connector.
	A parallel device, such as a printer, connects to the parallel connector.
	An external Personal System/2 (PS/2)-compatible mouse connects to the PS/2 mouse connector.
	An external PS/2-compatible keyboard or external numeric keypad connects to the PS/2 keyboard connector.
	An external CD-ROM, DVD-ROM, CD-RW, Zip 250, or diskette drive connects to the external media bay connector.

Use the following instructions to attach external devices to the APR.

**NOTICE: The NIC and the two PS/2 connectors on the back of the APR are inverted (as viewed while facing the back of the APR). Before attaching any cables, verify that the connector pins are aligned correctly to avoid damaging the connectors.**

1. Refer to Figure 1-1 to attach external devices to the appropriate connectors on the back of the APR.



*NOTES: If the cable connector from the external device has thumbscrews, be sure to tighten them to ensure a proper connection.*

*To connect the computer to a small computer system interface (SCSI) device, you must attach a SCSI PC Card to your computer. See "PC Cards" in your online Dell Latitude L400 User's Guide for information about using PC Cards.*

**NOTICE: Do not plug a telephone line into the NIC connector.**

For detailed information on using external devices with your computer, see "Using External Devices" in your online User's Guide.

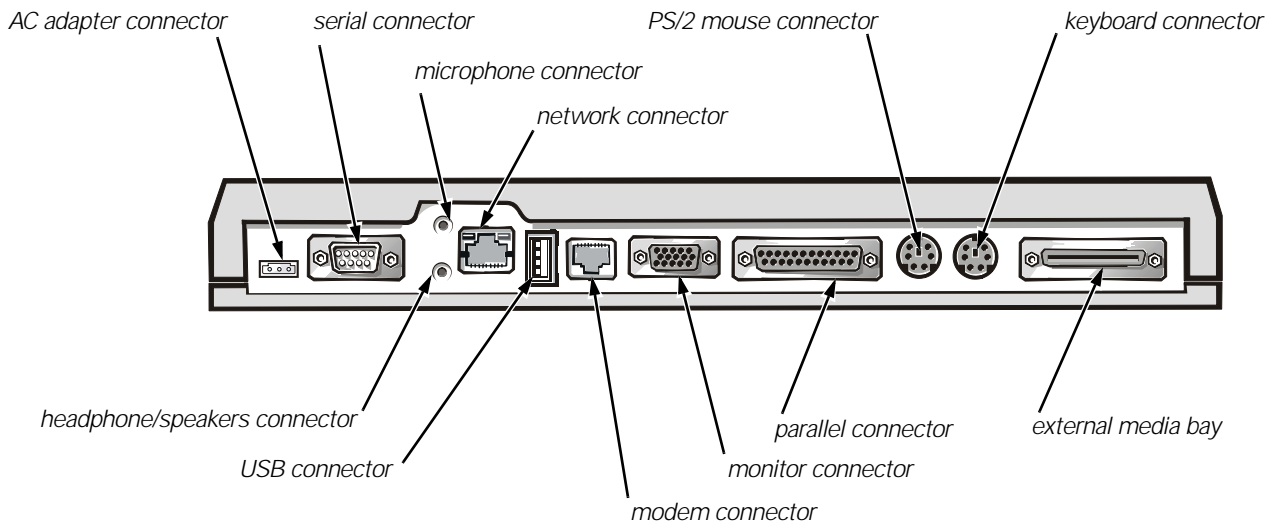

**Figure 1-1. Attaching External Devices to the APR**

2. Connect the external devices to their power sources, if applicable.



## Connecting the Computer to the APR

Use the following instructions to connect your computer to the APR.

1. Save all your work, and exit all application programs.
2. Shut down the computer.
3. If you have not already done so, connect the AC adapter to the connector on the APR (see Figure 1-1), and plug the AC power cable into an AC power source.
4. Place the back of the computer over the APR platform, aligning the sides of the computer between the platform wings (see Figure 1-2).

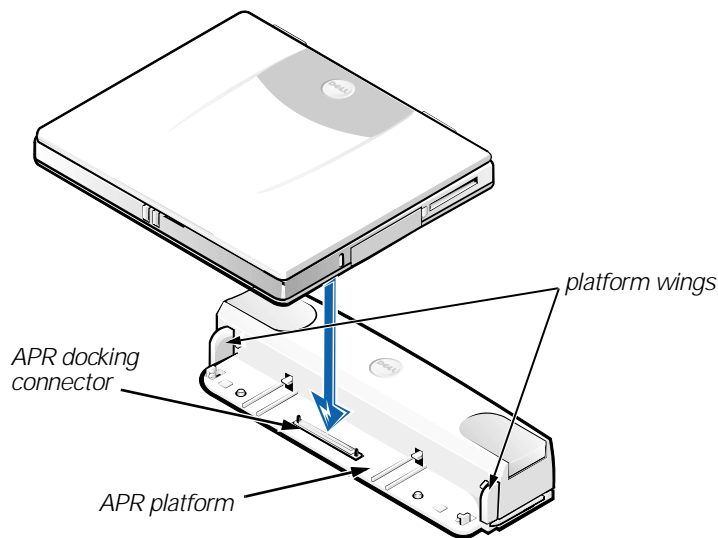

**Figure 1-2. Positioning the Computer on the APR**

5. Carefully lower the computer onto the APR platform, as shown in Figure 1-2, until the APR and computer docking connectors engage.

When you feel or hear a click, the computer is latched to the APR and the docking connectors are fully engaged.

**NOTICE: If the external devices that are connected through the APR are not functioning properly, make sure the computer and APR are properly connected by pressing down firmly on the two corners of the computer nearest the APR docking connector.**

6. Turn on the computer.

## ***Disconnecting the Computer From the APR***

Use the following procedure to disconnect the computer from the APR:

1. Save all your work, and exit all application programs.
2. Shut down the computer.
3. At the same time, press down on the left and right release buttons on the top of the replicator, as shown in Figure 1-3, to undock the computer.
4. Lift the computer up and away from the APR.

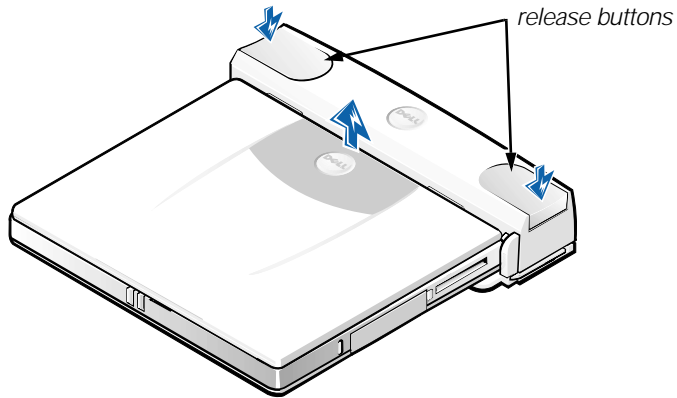

***Figure 1-3. Disconnecting the Computer From the APR***

## Security Lock

The security lock prevents unauthorized removal of your APR. The security lock swings out of the APR, as shown in Figure 1-4. An antitheft cable device is looped around an immovable object, passed through the security lock on the APR, and then locked to the security cable slot on the computer. For more information see the *Dell Latitude L400 User's Guide*.

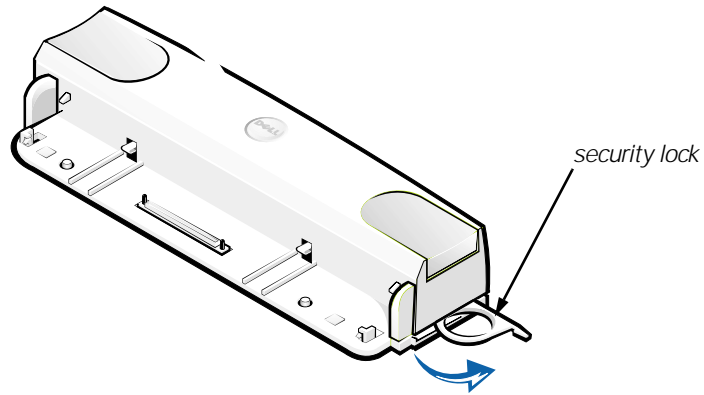

**Figure 1-4. APR Security Lock**

# Technical Specifications

Table 1-2 lists the technical specifications for the APR.

**Table 1-2. Technical Specifications**

<b>Physical</b>	
Height . . . . .	38.25 mm (1.5 inches)
Depth . . . . .	50.0 mm (2.0 inches)
Width . . . . .	298.0 mm (11.7 inches)
Weight . . . . .	389 g (0.86 lb)
<b>Connectors</b>	
Expansion (to connect to computer) . . . .	APR docking connector
Serial (DTE) . . . . .	9-pin male connector
Parallel . . . . .	25-hole female connector
PS/2-compatible keyboard/keypad . . . . .	6-hole external keyboard connector
PS/2-compatible mouse . . . . .	6-hole external mouse connector
LAN . . . . .	RJ45 connector
Modem . . . . .	RJ11 connector
Monitor . . . . .	15-hole female connector
Audio jacks . . . . .	microphone-in, one line-out audio
USB . . . . .	4-pin connectors
External media bay . . . . .	68-pin IDE/FDD connector
DC in . . . . .	three-pin DC power connector
<b>Environmental</b>	
Operating temperature . . . . .	5° to 35°C (41° to 95°F)
Storage temperature . . . . .	-20° to 60°C (-4° to 149°F)
Operating relative humidity . . . . .	20% to 80% (noncondensing)
Storage relative humidity . . . . .	8% to 90% (noncondensing)

## Regulatory Notices

Electromagnetic Interference (EMI) is any signal or emission, radiated in free space or conducted along power or signal leads, that endangers the functioning of a radio navigation or other safety service or seriously degrades, obstructs, or repeatedly interrupts a licensed radio communications service. Radio communications services include but are not limited to AM/FM commercial broadcast, television, cellular services, radar, air-traffic control, pager, and Personal Communication Services (PCS). These licensed services, along with unintentional radiators such as digital devices, including computer systems, contribute to the electromagnetic environment.

Electromagnetic Compatibility (EMC) is the ability of items of electronic equipment to function properly together in the electronic environment. While this computer system has been designed and determined to be compliant with regulatory agency limits for EMI, there is no guarantee that interference will not occur in a particular installation. If this equipment does cause interference with radio communications services, which can be determined by turning the equipment off and on, you are encouraged to try to correct the interference by one or more of the following measures:

- Reorient the receiving antenna.
- Relocate the computer with respect to the receiver.
- Move the computer away from the receiver.
- Plug the computer into a different outlet so that the computer and the receiver are on different branch circuits.

If necessary, consult a Dell Technical Support representative or an experienced radio/television technician for additional suggestions. You may find the *FCC Interference Handbook, 1986*, to be helpful. It is available from the U.S. Government Printing Office, Washington, DC 20402, Stock No. 004-000-00450-7 or on the World Wide Web at <http://www.fcc.gov/cib/Publications/tvibook.html>.

Dell computer systems are designed, tested, and classified for their intended electromagnetic environment. These electromagnetic environment classifications generally refer to the following harmonized definitions:

- Class A is typically for business or industrial environments.
- Class B is typically for residential environments.

Information Technology Equipment (ITE), including peripherals, expansion cards, printers, input/output (I/O) devices, monitors, and so on, that are integrated into or connected to the system should match the electromagnetic environment classification of the computer system.

**A Notice About Shielded Signal Cables: Use only shielded cables for connecting peripherals to any Dell device to reduce the possibility of interference with radio communications services. Using shielded cables ensures that you maintain the appropriate EMC classification for the intended environment. For parallel printers, a cable is available from Dell. If you prefer, you can order a cable from Dell on the World Wide Web at <http://www.dell.com/products/dellware/index.htm>.**

Most Dell computer systems are classified for Class B environments. To determine the electromagnetic classification for your system or device, refer to the following sections specific for each regulatory agency. Each section provides country-specific EMC/EMI or product safety information.

### ***FCC Notices (U.S. Only)***

Most Dell computer systems are classified by the Federal Communications Commission (FCC) as Class B digital devices. However, the inclusion of certain options can change the rating of some configurations to Class A. To determine which classification applies to your computer system, examine all FCC registration labels located on the bottom or back panel of your computer, on card-mounting brackets, and on the cards themselves. If any one of the labels carries a Class A rating, your entire system is considered to be a Class A digital device. If *all* labels carry an FCC Class B rating as distinguished by either an FCC ID number or the FCC logo, **(F)**our system is considered to be a Class B digital device.

Once you have determined your system's FCC classification, read the appropriate FCC notice. Note that FCC regulations provide that changes or modifications not expressly approved by Dell could void your authority to operate this equipment.

This device complies with Part 15 of the FCC Rules. Operation is subject to the following two conditions:

- This device may not cause harmful interference.
- This device must accept any interference received, including interference that may cause undesired operation.

### ***Class A***

This equipment has been tested and found to comply with the limits for a Class A digital device pursuant to Part 15 of the FCC Rules. These limits are designed to provide reasonable protection against harmful interference when the equipment is operated in a commercial environment. This equipment generates, uses, and can radiate radio frequency energy and, if not installed and used in accordance with the manufacturer's instruction manual, may cause harmful interference with radio communications. Operation of this equipment in a residential area is likely to cause harmful interference, in which case you will be required to correct the interference at your own expense.

### ***Class B***

This equipment has been tested and found to comply with the limits for a Class B digital device pursuant to Part 15 of the FCC Rules. These limits are designed to provide reasonable protection against harmful interference in a residential installation. This equipment generates, uses, and can radiate radio frequency energy and, if not installed and used in accordance with the manufacturer's instruction manual, may cause interference with radio communications. However, there is no guarantee that interference will not occur in a particular installation. If this equipment does cause harmful interference to radio or television reception, which can be determined by turning the equipment off and on, you are encouraged to try to correct the interference by one or more of the following measures:

- Reorient or relocate the receiving antenna.
- Increase the separation between the equipment and the receiver.
- Connect the equipment into an outlet on a circuit different from that to which the receiver is connected.
- Consult the dealer or an experienced radio/television technician for help.

The following information is provided on the device or devices covered in this document in compliance with FCC regulations:

- Model number: PRS
- Company name: Dell Computer Corporation  
EMC Engineering Department  
One Dell Way  
Round Rock, Texas 78682 USA  
512-338-4400

### *Modem Regulatory Information*

This equipment complies with Part 68 of the FCC rules. On the bottom of your computer is a label that contains, among other information, the FCC registration number and ringer equivalence number (REN) for your equipment. If requested, you must provide this information to the telephone company.

The REN is used to determine the quantity of devices that may be connected to the telephone line. Excessive RENs on the telephone line may result in the devices not ringing in response to an incoming call. In most areas, the sum of all the RENs on your telephone line should be less than five to ensure proper service from the telephone company. To be certain of the number of devices that you may connect to a line, as determined by the total RENs, contact your local telephone company.

The registration jack Universal Service Order Code (USOC) used by this equipment is RJ-11C. An FCC compliant telephone cord and modular plug is provided with this equipment. This equipment is designed to be connected to the telephone network or premises wiring using a compatible modular jack that is Part 68 compliant.

This equipment cannot be used on public coin-phone service provided by the telephone company. Connection to party line service is subject to state tariffs.

There are no user serviceable parts on the modem contained in your computer.

If your telephone equipment causes harm to the telephone network, the telephone company will notify you in advance that service may be temporarily discontinued. If advance notice is not practical, the telephone company will notify you as soon as possible. Also, you will be advised of your right to file a complaint with the FCC if you believe it is necessary.

The telephone company may make changes in its facilities, equipment, operations, or procedures that could affect the operation of this equipment. If this happens, the telephone company will provide advance notice in order for you to make necessary modifications to maintain uninterrupted service.

If you experience trouble with this telephone equipment, refer to the chapter titled "Getting Help" in your system's troubleshooting documentation or, for some systems, the section titled "Contacting Dell" in your system's online guide to find the appropriate telephone number for obtaining customer assistance. If the equipment is causing harm to the telephone network, the telephone company may request that you disconnect the equipment until the problem is resolved.

### *Fax Branding*

The Telephone Consumer Protection Act of 1991 makes it unlawful for any person to use a computer or other electronic device, including fax machines, to send any message unless such message clearly contains in a margin at the top or bottom of each transmitted page or on the first page of the transmission, the date and time it is sent, identification of the business, other entity, or individual sending the message, and the telephone number of the sending machine or such business, other entity, or individual. The telephone number provided may not be a 900 number or any other number for which charges exceed local or long-distance transmission charges.

### **IC Notice (Canada Only)**

Most Dell computers (and other Dell digital apparatus) are classified by the Industry Canada (IC) Interference-Causing Equipment Standard #3 (ICES-003) as Class B digital devices. To determine which classification (Class A or B) applies to your computer (or other Dell digital apparatus), examine all registration labels located on the bottom or the back panel of your computer (or other digital apparatus). A statement in the form of "IC Class A ICES-003" or "IC Class B ICES-003" will be located on one of these labels. Note that Industry Canada regulations provide that changes or modifications not expressly approved by Dell could void your authority to operate this equipment.

This Class B (or Class A, if so indicated on the registration label) digital apparatus meets the requirements of the Canadian Interference-Causing Equipment Regulations.

Cet appareil numérique de la Classe B (ou Classe A, si ainsi indiqué sur l'étiquette d'enregistrement) respecte toutes les exigences du Règlement sur le Matériel Brouilleur du Canada.

### *Modem Regulatory Information*

The IC label identifies certified equipment. This certification means that the equipment meets telecommunications network protective, operational, and safety requirements as prescribed in the appropriate Terminal Equipment Technical Requirements document(s). The IC label does not guarantee that the equipment will operate to the user's satisfaction.

Before installing this equipment, users should ensure that it is permissible to be connected to the facilities of the local telecommunications company. The equipment must also be installed using an acceptable method of connection. The customer should be aware that compliance with the above conditions may not prevent degradation of service in some situations.



Repairs to certified equipment should be coordinated by a representative designated by the supplier. Any repairs or alteration made by a user to this equipment, or equipment malfunctions, may give the telephone communications company cause to request the user to disconnect the equipment.

Users should ensure for their own protection, that the electrical ground connections of the power utility, telephone lines, and internal metallic water-pipe system, if present, are connected together. This precaution may be particularly important in rural areas.

**NOTICE: Users should not attempt to make such connections themselves. Contact the appropriate electric inspection authority, or electrician, as appropriate.**



*NOTE: The REN assigned to each terminal device provides an indication of the maximum number of terminals allowed to be connected to a telephone interface. The termination on an interface may consist of any combination of devices subject only to the requirement that the sum of the RENs of all the devices does not exceed the number five.*

The REN for the internal modem as stated on the IC regulatory label located on the bottom of the computer is 0.6B.

The following information is provided in compliance with IC regulations:

Dell Computer Corporation  
Warranty and Repair Service Center  
One Dell Way  
Round Rock, TX 78682 USA

512-338-4400

### **CE Notice (European Union)**

Marking by the symbol **CE** indicates compliance of this Dell system to the EMC Directive and the Low Voltage Directive of the European Union. Such marking is indicative that this Dell system meets the following technical standards:

- EN 55022 — "Limits and Methods of Measurement of Radio Interference Characteristics of Information Technology Equipment."
- EN 50082-1: 1992 — "Electromagnetic compatibility—Generic immunity standard Part 1: Residential, commercial, and light industry."
- EN 60950 — "Safety of Information Technology Equipment."



*NOTE: EN 55022 emissions requirements provide for two classifications:*

- *Class A is for typical commercial areas.*
- *Class B is for typical domestic areas.*

This Dell device is classified for use in a typical Class B domestic environment.

A "Declaration of Conformity" in accordance with the preceding directives and standards has been made and is on file at Dell Computer Corporation Products Europe BV, Limerick, Ireland.

### **EN 55022 Compliance (Czech Republic Only)**

This device belongs to Class B devices as described in EN 55022, unless it is specifically stated that it is a Class A device on the specification label. The following applies to devices in Class A of EN 55022 (radius of protection up to 30 meters). The user of the device is obliged to take all steps necessary to remove sources of interference to telecommunication or other devices.

Pokud není na typovém štítku počítače uvedeno, že spadá do třídy A podle EN 55022, spadá automaticky do třídy B podle EN 55022. Pro zařízení zařazená do třídy A (ochranné pásmo 30m) podle EN 55022 platí následující. Dojde-li k rušení telekomunikačních nebo jiných zařízení, je uživatel povinen provést taková opatření, aby rušení odstranil.

### **VCCI Notices (Japan Only)**

Most Dell computer systems are classified by the Voluntary Control Council for Interference (VCCI) as Class B Information Technology Equipment (ITE). However, the inclusion of certain options can change the rating of some configurations to Class A. ITE, including peripherals, expansion cards, printers, input/output (I/O) devices, monitors, and so on, integrated into or connected to the system, should match the electromagnetic environment classification (Class A or B) of the computer system.

To determine which classification applies to your computer system, examine the regulatory labels/markings (see Figures 1-5 and 1-6) located on the bottom or back panel of your computer. Once you have determined your system's VCCI classification, read the appropriate VCCI notice.

#### **Class A ITE**

この装置は、情報処理装置等電波障害自主規制協議会 (VCCI) の基準に基づくクラス A 情報技術装置です。この装置を家庭環境で使用すると電波妨害を引き起こすことがあります。この場合には使用者が適切な対策を講ずるよう要求されることがあります。

This is a Class A product based on the standard of the Voluntary Control Council for Interference (VCCI) for information technology equipment. If this equipment is used in a domestic environment, radio disturbance may arise. When such trouble occurs, the user may be required to take corrective actions.

## VCCI-A

**Figure 1-5. VCCI Class A ITE Regulatory Mark**

### Class B ITE

この装置は、情報処理装置等電波障害自主規制協議会 (VCCI) の基準に基づくクラス B 情報技術装置です。この装置は家庭環境で使用することを目的としていますが、この装置がラジオやテレビジョン受信機に近接して使用させると、受信障害を引き起こすことがあります。取扱説明書に従って正しい取り扱いをして下さい。

This is a Class B product based on the standard of the Voluntary Control Council for Interference (VCCI) for information technology equipment. If this equipment is used near a radio or television receiver in a domestic environment, it may cause radio interference. Install and use the equipment according to the instruction manual.



**Figure 1-6. VCCI Class B ITE Regulatory Mark**

### MIC Notice (Republic of Korea Only)

To determine which classification (Class A or B) applies to your computer (or other Dell digital device), examine the Republic of Korean Ministry of Information and Communications (MIC) registration labels located on your computer (or other Dell digital device). The MIC label may be located separately from the other regulatory marking applied to your product. Line three of the label identifies the emissions class for the product—“(A)” for Class A products or “(B)” for Class B products.



*NOTE: MIC emissions requirements provide for two classifications:*

- *Class A devices are for business purposes.*
- *Class B devices are for nonbusiness purposes.*

## Class A Device

기종별	사용자 안내문
A급 기기 (업무용 정보통신기기)	이 기기는 업무용으로 전자파적합등록을 한 기기이오니 판매자 또는 사용자는 이 점을 주의하시기 바라며 만약 잘못 판매 또는 구입하였을 때에는 가정용으로 교환하시기 바랍니다.

Please note that this device has been approved for business purposes with regard to electromagnetic interference. If you find that this device is not suitable for your use, you may exchange it for a nonbusiness-purpose device.



1. 기기의 명칭(모델명):
2. 인증번호:
3. 인증받은 자의 상호: (A)
4. 제조년월일:
5. 제조자/제조국가:

## Class B Device

기종별	사용자 안내문
B급 기기 (가정용 정보통신기기)	이 기기는 가정용으로 전자파적합등록을 한 기기로서 주거지역에서는 물론 모든 지역에서 사용할 수 있습니다.

Please note that this device has been approved for nonbusiness purposes and may be used in any environment, including residential areas.



1. 기기의 명칭(모델명):
2. 인증번호:
3. 인증받은 자의 상호: (B)
4. 제조년월일:
5. 제조자/제조국가:

### **Polish Center for Testing and Certification Notice**

The equipment should draw power from a socket with an attached protection circuit (a three-prong socket). All equipment that works together (computer, monitor, printer, and so on) should have the same power supply source.

The phasing conductor of the room's electrical installation should have a reserve short-circuit protection device in the form of a fuse with a nominal value no larger than 16 amperes (A).

To completely switch off the equipment, the power supply cable must be removed from the power supply socket, which should be located near the equipment and easily accessible.

A protection mark "B" confirms that the equipment is in compliance with the protection usage requirements of standards PN-93/T-42107 and PN-EN 55022: 1996.

### ***Wymagania Polskiego Centrum Badań i Certyfikacji***

Urządzenie powinno być zasilane z gniazda z przyłączonym obwodem ochronnym (gniazdo z kołkiem). Współpracujące ze sobą urządzenia (komputer, monitor, drukarka) powinny być zasilane z tego samego źródła.

Instalacja elektryczna pomieszczenia powinna zawierać w przewodzie fazowym rezerwową ochronę przed zwarciami, w postaci bezpiecznika o wartości znamionowej nie większej niż 16A (amperów).

W celu całkowitego wyłączenia urządzenia z sieci zasilania, należy wyjąć wtyczkę kabla zasilającego z gniazdka, które powinno znajdować się w pobliżu urządzenia i być łatwo dostępne.

Znak bezpieczeństwa "B" potwierdza zgodność urządzenia z wymaganiami bezpieczeństwa użytkownika zawartymi w PN-93/T-42107 i PN-EN 55022:1996.

Jeżeli na tabliczce znamionowej umieszczono informację, że urządzenie jest klasy A, to oznacza to, że urządzenie w środowisku mieszkalnym może powodować zakłócenia radioelektryczne. W takich przypadkach można żądać od jego użytkownika zastosowania odpowiednich środków zaradczych.

### ***Pozostałe instrukcje bezpieczeństwa***

- Nie należy używać wtyczek adapterowych lub usuwać kołka obwodu ochronnego z wtyczki. Jeżeli konieczne jest użycie przedłużacza to należy użyć przedłużacza 3-żyłowego z prawidłowo połączonym przewodem ochronnym.
- System komputerowy należy zabezpieczyć przed nagłymi, chwilowymi wzrostami lub spadkami napięcia, używając eliminatora przepięć, urządzenia dopasowującego lub bezzakłóceniewego źródła zasilania.
- Należy upewnić się, aby nic nie leżało na kablach systemu komputerowego, oraz aby kable nie były umieszczone w miejscu, gdzie można byłoby na nie nadeptywać lub potykać się o nie.
- Nie należy rozlewać napojów ani innych płynów na system komputerowy.
- Nie należy wpychać żadnych przedmiotów do otworów systemu komputerowego, gdyż może to spowodować pożar lub porażenie prądem, poprzez zwarcie elementów wewnętrznych.
- System komputerowy powinien znajdować się z dala od grzejników i źródeł ciepła. Ponadto, nie należy blokować otworów wentylacyjnych. Należy unikać kładzenia luźnych papierów pod komputer oraz umieszczania komputera w ciasnym miejscu bez możliwości cyrkulacji powietrza wokół niego.

## ***NOM Information (Mexico Only)***

The following information is provided on the device(s) described in this document in compliance with the requirements of the official Mexican standards (NOM):

Exporter:	Dell Computer Corporation One Dell Way Round Rock, TX 78682
Importer:	Dell Computer de México, S.A. de C.V. Paseo de la Reforma 2620 - 11° Piso Col. Lomas Altas 11950 México, D.F.
Ship to:	Dell Computer de México, S.A. de C.V. al Cuidado de Kuehne & Nagel de México S. de R.I. Avenida Soles No. 55 Col. Peñon de los Baños 15520 México, D.F.
Supply input voltage:	100-240 VAC
Frequency:	50-60 Hz
Current consumption:	1.5 A
Output voltage:	19 VDC
Output current:	2.64 A

## **Información para NOM (únicamente para México)**

La información siguiente se proporciona en el dispositivo o en los dispositivos descritos en este documento, en cumplimiento con los requisitos de la Norma Oficial Mexicana (NOM):

Exportador:	Dell Computer Corporation One Dell Way Round Rock, TX 78682
Importador:	Dell Computer de México, S.A. de C.V. Paseo de la Reforma 2620 - 11° Piso Col. Lomas Altas 11950 México, D.F.
Embarcar a:	Dell Computer de México, S.A. de C.V. al Cuidado de Kuehne & Nagel de México S. de R.I. Avenida Soles No. 55 Col. Peñon de los Baños 15520 México, D.F.
Voltaje de entrada de alimentación:	100-240 VAC
Frecuencia:	50-60 HZ
Consumo eléctrico:	1.5 A
Voltaje de salida:	19 VDC
Corriente de salida:	2.64 A

## BSMI Notice (Taiwan Only)

### BSMI 通告 (僅限於台灣)

大多數的 Dell 電腦系統被 BSMI (經濟部標準檢驗局) 劃分為乙類數位裝置。但是，使用某些選件會使有些組態的等級變成甲類。若要確定您的電腦系統適用等級，請檢查所有位於電腦底部或背面板、擴充卡安裝托架，以及擴充卡上的 BSMI 註冊標籤。如果其中有一甲類標籤，即表示您的系統為甲類數位裝置。如果只有 BSMI 的檢驗號碼標籤，則表示您的系統為乙類數位裝置。

一旦確定了系統的 BSMI 等級，請閱讀相關的 BSMI 通告。請注意，BSMI 通告規定凡是未經 Dell Computer Corporation 明確批准的擅自變更或修改，將導致您失去此設備的使用權。

此裝置符合 BSMI (經濟部標準檢驗局) 的規定，使用時須符合以下兩項條件：

- 此裝置不會產生有害干擾。
- 此裝置必須能接受所接收到的干擾，包括可能導致無法正常作業的干擾。

### 甲類

此設備經測試證明符合 BSMI (經濟部標準檢驗局) 之甲類數位裝置的限制規定。這些限制的目的是為了在商業環境中使用此設備時，能提供合理的保護以防止有害的干擾。此設備會產生、使用並散發射頻能量；如果未遵照製造廠商的指導手冊來安裝和使用，可能會干擾無線電通訊。請勿在住宅區使用此設備。

#### 警告使用者：

這是甲類的資訊產品，在居住的環境中使用時，可能會造成射頻干擾，在這種情況下，使用者會被要求採取某些適當的對策。



## 乙類

此設備經測試證明符合 BSMI (經濟部標準檢驗局) 之乙類數位裝置的限制規定。這些限制的目的是為了在住宅區安裝時，能防止有害的干擾，提供合理的保護。此設備會產生、使用並散發射頻能量；如果未遵照製造廠商的指導手冊來安裝和使用，可能會干擾無線電通訊。但是，這並不保證在個別的安装中不會產生干擾。您可以透過關閉和開啓此設備來判斷它是否會對廣播和電視收訊造成干擾；如果確實如此，我們建議您嘗試以下列一種或多種方法來排除干擾：

- 重新調整天線的接收方向或重新放置接收天線。
- 增加設備與接收器的距離。
- 將設備連接至不同的插座，使設備與接收器連接在不同的電路上。
- 請向經銷商或有經驗的無線電/電視技術人員查詢，以獲得幫助。

### **CE Mark Notice**

This device complies with the requirements of the European Directive 1999/5/EC.

## ***New Zealand Telecom Warnings***

### ***General***

"The grant of a Telepermit for any item of terminal equipment indicates only that Telecom has accepted that the item complies with minimum conditions for connection to its network. It indicates no endorsement of the product by Telecom, nor does it provide any sort of warranty. Above all, it provides no assurance that any item will work correctly in all respects with another item of Telepermitted equipment of a different make or model, nor does it imply that any product is compatible with all of Telecom's network services."

"This equipment does not fully meet Telecom impedance requirements. Performance limitations may occur when used in conjunction with some parts of the network. Telecom will accept no responsibility should difficulties arise in such circumstances."

"This equipment shall not be set up to make automatic calls to the Telecom '111' Emergency Service."

"If a charge for local calls is unacceptable, the 'Dial' button should NOT be used for local calls. Only the 7-digits of the local number should be dialed from your telephone. DO NOT dial the area code digit or the '0' prefix."

"This equipment may not provide for the effective hand-over of a call to another device connected to the same line."

## ***Important Notice***

" Under power failure conditions, this telephone may not operate. Please ensure that a separate telephone, not dependent on local power, is available for emergency use."

" Some parameters required for compliance with Telecom's Telepermit requirements are dependent on the equipment (PC) associated with this device. The associated equipment shall be set to operate within the following limits for compliance with Telecom's Specification:

1. There shall be no more than 10 call attempts to the same number within any 30-minute period for any single manual call initiation, and the equipment shall go on-hook for a period of not less than 30 seconds between the end of one attempt and the beginning of the next attempt.
2. Where automatic calls are made to different numbers, the equipment shall go on-line for a period of not less than 5 seconds between the end of one attempt and the beginning of the next attempt.
3. The equipment shall be set to ensure that calls are answered between 3 and 30 seconds of receipt of ringing."

"All persons using this device for recording telephone conversations shall comply with New Zealand law. This requires that at least one party to the conversation is to be aware that it is being recorded. In addition, the Principles enumerated in the Privacy Act of 1993 shall be complied with in respect to the nature of the personal information collected, the purpose for its collection, how it is used and what is disclosed to any other party."

## ***Limited Warranty and Return Policy***

### ***Three-Year Limited Warranty (U.S. Only)***

Dell manufactures its hardware products from parts and components that are new or equivalent to new in accordance with industry-standard practices. Dell warrants that the hardware products it manufactures will be free from defects in materials and workmanship. The limited warranty term is three years beginning on the date of invoice, as described in the following text.

Damage due to shipping the products to you is covered under this limited warranty. Otherwise, this limited warranty does not cover damage due to external causes, including accident, abuse, misuse, problems with electrical power, servicing not authorized by Dell, usage not in accordance with product instructions, failure to perform required preventive maintenance, and problems caused by use of parts and components not supplied by Dell.

This limited warranty does not cover any items that are in one or more of the following categories: software; external devices (except as specifically noted); accessories or parts added to a Dell computer after the computer is shipped from Dell; accessories or parts added to a Dell computer through Dell's system integration department; accessories or parts that are not installed in the Dell factory; or DellWare™ products.

Monitors, keyboards, and mice that are Dell-branded or that are included on Dell's standard price list are covered under this limited warranty; all other monitors, keyboards, and mice (including those sold through the DellWare program) are not covered. Batteries for portable computers are covered only during the initial one-year period of this limited warranty.

### Coverage During Year One

During the one-year period beginning on the invoice date, Dell will repair or replace products covered under this limited warranty that are returned to Dell's facility. To request warranty service, you must call Dell's Customer Technical Support within the warranty period. Refer to the section titled "Contacting Dell" in your computer's online guide to find the appropriate telephone number for obtaining customer assistance. If warranty service is required, Dell will issue a Return Material Authorization Number. You must ship the products back to Dell in their original or equivalent packaging, prepay shipping charges, and insure the shipment or accept the risk of loss or damage during shipment. Dell will ship the repaired or replacement products to you freight prepaid if you use an address in the continental U.S., where applicable. Shipments to other locations will be made freight collect.



*NOTE: Before you ship the product(s) to Dell, back up the data on the hard-disk drive(s) and any other storage device(s) in the product(s). Remove any removable media, such as diskettes, CDs, or PC Cards. Dell does not accept liability for lost data or software.*

Dell owns all parts removed from repaired products. Dell uses new and reconditioned parts made by various manufacturers in performing warranty repairs and building replacement products. If Dell repairs or replaces a product, its warranty term is not extended.

### Coverage During Years Two and Three

During the second and third years of this limited warranty, Dell will provide, on an exchange basis and subject to Dell's Exchange Policy in effect on the date of the exchange, replacement parts for the Dell hardware product(s) covered under this limited warranty when a part requires replacement. You must report each instance of hardware failure to Dell's Customer Technical Support in advance to obtain Dell's concurrence that a part should be replaced and to have Dell ship the replacement part. Dell will ship parts (freight prepaid) if you use an address in the continental U.S., where applicable. Shipments to other locations will be made freight collect. Dell will include a prepaid shipping container with each replacement part for your use in returning the replaced part to Dell. Replacement parts are new or reconditioned. Dell may provide replacement parts made by various manufacturers when supplying parts to you. The warranty term for a replacement part is the remainder of the limited warranty term.

You will pay Dell for replacement parts if the replaced part is not returned to Dell. The process for returning replaced parts, and your obligation to pay for replacement parts if you do not return the replaced parts to Dell, will be in accordance with Dell's Exchange Policy in effect on the date of the exchange.

You accept full responsibility for your software and data. Dell is not required to advise or remind you of appropriate backup and other procedures.

### *General Provisions*

THIS LIMITED WARRANTY GIVES YOU SPECIFIC LEGAL RIGHTS WHICH VARY FROM STATE TO STATE (OR JURISDICTION TO JURISDICTION). DELL'S RESPONSIBILITY FOR MALFUNCTIONS AND DEFECTS IN HARDWARE IS LIMITED TO REPAIR AND REPLACEMENT AS SET FORTH IN THIS LIMITED WARRANTY STATEMENT. ALL EXPRESS AND IMPLIED WARRANTIES FOR THE PRODUCT, INCLUDING BUT NOT LIMITED TO ANY IMPLIED WARRANTIES OF AND CONDITIONS OF MERCHANTABILITY AND FITNESS FOR A PARTICULAR PURPOSE, ARE LIMITED IN DURATION TO THE WARRANTY PERIOD SET FORTH ABOVE AND NO WARRANTIES, WHETHER EXPRESS OR IMPLIED, WILL APPLY AFTER SUCH PERIOD.

SOME STATES (OR JURISDICTIONS) DO NOT ALLOW LIMITATIONS ON HOW LONG AN IMPLIED WARRANTY LASTS, SO THE PRECEDING LIMITATION MAY NOT APPLY TO YOU.

DELL DOES NOT ACCEPT LIABILITY BEYOND THE REMEDIES SET FORTH IN THIS LIMITED WARRANTY STATEMENT OR LIABILITY FOR INCIDENTAL OR CONSEQUENTIAL DAMAGES, INCLUDING WITHOUT LIMITATION ANY LIABILITY FOR PRODUCTS NOT BEING AVAILABLE FOR USE OR FOR LOST DATA OR SOFTWARE.

SOME STATES (OR JURISDICTIONS) DO NOT ALLOW THE EXCLUSION OR LIMITATION OF INCIDENTAL OR CONSEQUENTIAL DAMAGES, SO THE PRECEDING EXCLUSION OR LIMITATION MAY NOT APPLY TO YOU.

These provisions apply to Dell's three-year limited warranty only. For provisions of any service contract covering your computer, refer to your invoice or the separate service contract that you will receive.

If Dell elects to exchange a computer or component, the exchange will be made in accordance with Dell's Exchange Policy in effect on the date of the exchange. In any instance in which Dell issues a Return Material Authorization Number, Dell must receive the product(s) for repair prior to the expiration of the warranty period in order for the repair(s) to be covered by the limited warranty.



*NOTE: If you chose one of the available warranty and service options in place of the standard three-year limited warranty described in the preceding text, the option you chose will be listed on your invoice.*

### ***Three-Year Limited Warranty (Canada Only)***

Dell Computer Corporation ("Dell") manufactures its hardware products from parts and components that are new or equivalent to new in accordance with industry-standard practices. Dell warrants that the hardware products it manufactures will be free from defects in materials and workmanship. The warranty term is three years beginning on the date of invoice, as described in the following text.

Damage due to shipping the products to you is covered under this limited warranty. Otherwise, this limited warranty does not cover damage due to external causes,

including accident, abuse, misuse, problems with electrical power, servicing not authorized by Dell, usage not in accordance with product instructions, failure to perform required preventive maintenance, and problems caused by use of parts and components not supplied by Dell.

This limited warranty does not cover any items that are in one or more of the following categories: software; external devices (except as specifically noted); accessories or parts added to a Dell computer after the computer is shipped from Dell; accessories or parts added to a Dell computer through Dell's system integration department; accessories or parts that are not installed in the Dell factory; or DellWare products. Monitors, keyboards, and mice that are Dell-branded or that are included on Dell's standard price list are covered under this limited warranty; all other monitors, keyboards, and mice (including those sold through the DellWare program) are not covered. Batteries are covered only during the initial one-year period of this limited warranty.

### *Coverage During Year One*

During the one-year period beginning on the invoice date, Dell will repair or replace products covered under this limited warranty that are returned to Dell's facility. To request warranty service, you must call Dell's Customer Technical Support within the warranty period. Refer to the section titled "Contacting Dell" in your computer's online guide to find the appropriate telephone number for obtaining customer assistance. If warranty service is required, Dell will issue a Return Material Authorization Number. You must ship the products back to Dell in their original or equivalent packaging, prepay shipping charges, and insure the shipment or accept the risk of loss or damage during shipment. Dell will ship the repaired or replacement products to you freight prepaid if you use an address in Canada, where applicable. Shipments to other locations will be made freight collect.



*NOTE: Before you ship the product(s) to Dell, back up the data on the hard-disk drive(s) and any other storage device(s) in the product(s). Remove any removable media, such as diskettes, CDs, or PC Cards. Dell does not accept liability for lost data or software.*

Dell owns all parts removed from repaired products. Dell uses new and reconditioned parts made by various manufacturers in performing warranty repairs and building replacement products. If Dell repairs or replaces a product, its warranty term is not extended.

### *Coverage During Years Two and Three*

During the second and third years of this limited warranty, Dell will provide, on an exchange basis and subject to Dell's Exchange Policy in effect on the date of the exchange, replacement parts for the Dell hardware product(s) covered under this limited warranty when a part requires replacement. You must report each instance of hardware failure to Dell's Customer Technical Support in advance to obtain Dell's concurrence that a part should be replaced and to have Dell ship the replacement part. Dell will ship parts (freight prepaid) if you use an address in Canada, where applicable. Shipments to other locations will be made freight collect. Dell will include a prepaid shipping container with each replacement part for your use in returning the replaced part to Dell. Replacement parts are new or reconditioned. Dell may provide

replacement parts made by various manufacturers when supplying parts to you. The warranty term for a replacement part is the remainder of the limited warranty term.

You will pay Dell for replacement parts if the replaced part is not returned to Dell. The process for returning replaced parts, and your obligation to pay for replacement parts if you do not return the replaced parts to Dell, will be in accordance with Dell's Exchange Policy in effect on the date of the exchange.

You accept full responsibility for your software and data. Dell is not required to advise or remind you of appropriate backup and other procedures.

### *General Provisions*

DELL MAKES NO EXPRESS WARRANTIES OR CONDITIONS BEYOND THOSE STATED IN THIS LIMITED WARRANTY STATEMENT. DELL DISCLAIMS ALL OTHER WARRANTIES AND CONDITIONS, EXPRESS OR IMPLIED, INCLUDING WITHOUT LIMITATION IMPLIED WARRANTIES AND CONDITIONS OF MERCHANTABILITY AND FITNESS FOR A PARTICULAR PURPOSE. SOME STATES (OR JURISDICTIONS) DO NOT ALLOW LIMITATIONS ON IMPLIED WARRANTIES OR CONDITIONS, SO THIS LIMITATION MAY NOT APPLY TO YOU.

DELL'S RESPONSIBILITY FOR MALFUNCTIONS AND DEFECTS IN HARDWARE IS LIMITED TO REPAIR AND REPLACEMENT AS SET FORTH IN THIS LIMITED WARRANTY STATEMENT. THESE WARRANTIES GIVE YOU SPECIFIC LEGAL RIGHTS, AND YOU MAY ALSO HAVE OTHER RIGHTS, WHICH VARY FROM STATE TO STATE (OR JURISDICTION TO JURISDICTION).

DELL DOES NOT ACCEPT LIABILITY BEYOND THE REMEDIES SET FORTH IN THIS LIMITED WARRANTY STATEMENT OR LIABILITY FOR INCIDENTAL OR CONSEQUENTIAL DAMAGES, INCLUDING WITHOUT LIMITATION ANY LIABILITY FOR PRODUCTS NOT BEING AVAILABLE FOR USE OR FOR LOST DATA OR SOFTWARE.

SOME STATES (OR JURISDICTIONS) DO NOT ALLOW THE EXCLUSION OR LIMITATION OF INCIDENTAL OR CONSEQUENTIAL DAMAGES, SO THE PRECEDING EXCLUSION OR LIMITATION MAY NOT APPLY TO YOU.

These provisions apply to Dell's three-year limited warranty only. For provisions of any service contract covering your computer, refer to your invoice or the separate service contract that you will receive.

If Dell elects to exchange a computer or component, the exchange will be made in accordance with Dell's Exchange Policy in effect on the date of the exchange. In any instance in which Dell issues a Return Material Authorization Number, Dell must receive the product(s) for repair prior to the expiration of the warranty period in order for the repair(s) to be covered by the limited warranty.



*NOTE: If you chose one of the available warranty and service options in place of the standard three-year limited warranty described in the preceding text, the option you chose will be listed on your invoice.*

## ***One-Year End-User Manufacturer Guarantee (Latin America and the Caribbean Only)***

### *Guarantee*

Dell Computer Corporation ("Dell") warrants to the end user in accordance with the following provisions that its branded hardware products, purchased by the end user from a Dell company or an authorized Dell distributor in Latin America or the Caribbean, will be free from defects in materials, workmanship, and design affecting normal use, for a period of one year from the original purchase date. Products for which proper claims are made will, at Dell's option, be repaired or replaced at Dell's expense. Dell owns all parts removed from repaired products. Dell uses new and reconditioned parts made by various manufacturers in performing repairs and building replacement products.

### *Exclusions*

This Guarantee does not apply to defects resulting from: improper or inadequate installation, use, or maintenance; actions or modifications by unauthorized third parties or the end user; accidental or willful damage; or normal wear and tear.

### *Making a Claim*

Claims must be made in Latin America or the Caribbean by contacting the Dell point of sale within the guarantee period. The end user must always supply proof of purchase, indicating name and address of the seller, date of purchase, model and serial number, name and address of the customer, and details of symptoms and configuration at the time of malfunction, including peripherals and software used. Otherwise, Dell may refuse the guarantee claim. Upon diagnosis of a warranted defect, Dell will make arrangements and pay for ground freight and insurance to and from Dell's repair/replacement center. The end user must ensure that the defective product is available for collection properly packed in original or equally protective packaging together with the details listed above and the return number provided to the end user by Dell.

### *Limitation and Statutory Rights*

Dell makes no other warranty, guarantee or like statement other than as explicitly stated above, and this Guarantee is given in place of all other guarantees whatsoever, to the fullest extent permitted by law. In the absence of applicable legislation, this Guarantee will be the end user's sole and exclusive remedy against Dell or any of its affiliates, and neither Dell nor any of its affiliates shall be liable for loss of profit or contracts, or any other indirect or consequential loss arising from negligence, breach of contract, or howsoever.

This Guarantee does not impair or affect mandatory statutory rights of the end user against and/or any rights resulting from other contracts concluded by the end user with Dell and/or any other seller.

Dell World Trade LP  
One Dell Way, Round Rock, TX 78682, USA

Dell Computadores do Brasil Ltda (CNPJ No. 72.381.189/0001-10)/  
Dell Commercial do Brasil Ltda (CNPJ No. 03 405 822/0001-40)  
Avenida Industrial Belgraf, 400  
92990-000 - Eldorado do Sul – RS - Brasil

Dell Computer de Chile Ltda  
Coyancura 2283, Piso 3- Of.302,  
Providencia, Santiago - Chile

Dell Computer de Colombia Corporation  
Carrera 7 #115-33 Oficina 603  
Bogota, Colombia

Dell Computer de Mexico SA de CV  
Rio Lerma #302- 4 Piso  
Col. Cuauhtemoc, Mexico, D.F. 06500

### ***“Total Satisfaction” Return Policy (U.S. and Canada Only)***

If you are an end-user customer who bought new products directly from a Dell company, you may return them to Dell within 30 days of the date of invoice for a refund or credit of the product purchase price. If you are an end-user customer who bought reconditioned or refurbished products from a Dell company, you may return them to Dell within 14 days of the date of invoice for a refund or credit of the product purchase price. In either case, the refund or credit will not include any shipping and handling charges shown on your invoice. If you are an organization that bought the products under a written agreement with Dell, the agreement may contain different terms for the return of products than specified by this policy.

To return products, you must call Dell Customer Service to receive a Credit Return Authorization Number. Refer to the section titled “Contacting Dell” in your computer’s online guide to find the appropriate telephone number for obtaining customer assistance. To expedite the processing of your refund or credit, Dell expects you to return the products to Dell in their original packaging within five days of the date that Dell issues the Credit Return Authorization Number. You must also prepay shipping charges and insure the shipment or accept the risk of loss or damage during shipment. You may return software for refund or credit only if the sealed package containing the diskette(s) or CD(s) is unopened. Returned products must be in as-new condition, and all of the manuals, diskette(s), CD(s), power cables, and other items included with a product must be returned with it. For customers who want to return, for refund or credit only, either applications software or an operating system that has been installed by Dell, the whole system must be returned, along with any media and documentation that may have been included in the original shipment.

This “Total Satisfaction” Return Policy does not apply to DellWare products, which may be returned under DellWare’s then-current return policy. In addition, reconditioned parts purchased through Dell Spare Parts Sales in Canada are nonreturnable.



Réplicateur de port avancé Dell™ Latitude™ L400

# GUIDE DE L'UTILISATEUR

[www.dell.com](http://www.dell.com)  
[support.dell.com](http://support.dell.com)



## ***Remarques, avis et précautions***

Dans ce guide, certains blocs de texte sont accompagnés d'une icône et imprimés en caractères gras ou en caractères italiques. Ces paragraphes correspondent à des remarques, des avis et des précautions qui sont utilisés comme suit :



*REMARQUE* : Une *REMARQUE* fournit des informations importantes qui vous aident à mieux utiliser votre système.

**AVIS** : Un **AVIS** vous avertit d'un risque de dommage matériel ou de perte de données et vous indique comment éviter le problème.



**PRÉCAUTION** : Une **PRÉCAUTION** vous avertit d'un risque de blessure corporelle et vous indique comment éviter le problème.

---

Les informations contenues dans ce document sont sujettes à modification sans préavis.  
© 1999 – 2001 Dell Computer Corporation. Tous droits réservés.

Toute reproduction sous quelque forme que ce soit sans l'autorisation écrite de Dell Computer Corporation est strictement interdite.

Marques utilisées dans ce document : *Dell*, le logo *DELL*, *Latitude* et *DellWare* sont des marques de Dell Computer Corporation.

D'autres marques et noms commerciaux peuvent être utilisés dans ce document pour faire référence à des entités se réclamant de ces marques et de ces noms ou à leurs produits. Dell dénie tout intérêt propriétaire aux marques et aux noms commerciaux autres que les siens.



# **Dell™ Latitude™ L400**

## **Réplicateur de port avancé**

### **Guide de l'utilisateur**

Le réplicateur de port avancé (APR) permet d'intégrer votre ordinateur Dell Latitude L400 rapidement et facilement dans un environnement de bureau. Utilisez les instructions fournies dans ce document pour connecter des périphériques externes ainsi que votre ordinateur à l'APR.

### **Consignes de sécurité**

Utilisez les consignes de sécurité suivantes pour vous aider à protéger votre APR de dommages éventuels et pour garantir votre sécurité personnelle :

- N'essayez pas de réparer l'ARP vous-même. Suivez toujours scrupuleusement les instructions d'installation.
- Assurez-vous que rien ne repose sur le cordon d'alimentation de l'adaptateur CA/CC et que ce cordon n'est pas placé dans un endroit où l'on pourrait marcher ou trébucher dessus.
- L'adaptateur CA/CC doit se trouver dans une zone aérée, comme sur un bureau ou sur le sol, lorsqu'il est utilisé pour alimenter l'APR. Ne couvrez pas l'adaptateur CA/CC de papiers ou d'autres objets susceptibles d'empêcher son refroidissement. N'utilisez pas l'adaptateur CA/CC à l'intérieur d'une sacoche.
- N'utilisez pas votre ARP dans un environnement humide, par exemple près d'une baignoire, d'un évier, d'une piscine ou dans un sous-sol humide.
- N'insérez pas d'objets dans les ouïes d'aération ou dans les ouvertures de votre APR. Ceci peut créer un incendie ou un choc électrique en mettant des composants internes en court-circuit.
- Utilisez uniquement l'adaptateur CA/CC conçu pour être utilisé avec cet APR, comme le précise ce guide. Le recours à un autre type d'adaptateur CA/CC présente un risque d'incendie ou d'explosion.

- Avant de raccorder l'APR à une source d'alimentation, assurez-vous que la tension du secteur est compatible avec la tension d'entrée de l'adaptateur CA/CC :
  - 115 volts (V)/60 hertz (Hz) dans presque toute l'Amérique du Nord et du Sud et dans certains pays d'Extrême-Orient comme la Corée du Sud et Taiwan.
  - 100 V/50 Hz dans l'est du Japon et 100 V/60 Hz dans l'ouest du Japon.
  - 230 V/50 Hz dans presque toute l'Europe, le Moyen-Orient et l'Extrême-Orient.
- Pour éviter toute décharge électrique, branchez l'adaptateur CA/CC et les cordons d'alimentation électrique de l'ordinateur et de ses périphériques sur des prises possédant un circuit de mise à la terre adéquat. Ces câbles électriques sont équipés de connecteurs à trois broches pour assurer une mise à la terre correcte. N'utilisez pas de prises d'adaptation et n'essayez pas de contourner la mise à la terre. Si vous devez utiliser une rallonge, utilisez une rallonge à trois fils avec des prises de terre.
- Si vous raccordez une rallonge à votre adaptateur CA/CC, assurez-vous que l'intensité totale du courant drainé par tous les appareils raccordés à cette rallonge ne dépasse pas la limite de cette dernière.
- Pour mettre l'APR totalement hors tension, éteignez l'ordinateur et débranchez l'adaptateur CA/CC de la prise de courant.
- Si votre ordinateur comprend un modem intégré ou en option (carte PC), le câble utilisé avec le modem doit être de type 26 AWG (American wire gauge), et comporter une fiche modulaire conforme à la norme FCC RJ-11.
- Débranchez le modem de la ligne téléphonique pendant un orage électrique pour éviter le risque très faible de choc électrique causé par un éclair et transmis par la ligne téléphonique.
- Pour éviter tout risque de décharge électrique, n'effectuez aucun branchement ou débranchement, ni aucune opération de maintenance ou de reconfiguration de ce produit pendant un orage.
- Lorsque vous installez l'APR pour travailler, placez-le sur une surface plane.
- Protégez l'APR des dangers que représentent la saleté, la poussière, la nourriture, les liquides, des températures extrêmes ou une surexposition au soleil.
- Lorsque vous faites passer votre APR d'un environnement à un autre de température ou d'humidité très différentes, de la condensation peut se former sur l'ordinateur ou à l'intérieur de celui-ci. Pour éviter d'endommager l'ARP, patientez suffisamment pour que cette humidité s'évapore avant d'utiliser la machine.







**AVIS : Lorsque vous faites passer l'APR d'un milieu à basse température à un milieu plus chaud, ou vice versa, laissez l'APR s'acclimater à la température ambiante avant de l'allumer.**

- Quand vous débranchez un câble, tirez sur la prise ou sur la boucle prévue à cet effet, mais jamais sur le câble lui-même. Quand vous débroschez des connecteurs, conservez-les alignés de manière à éviter de tordre leurs broches. De même, lorsque vous connectez un câble, assurez-vous au préalable que les connecteurs sont bien orientés et alignés.
- Manipulez l'APR avec précaution.
- Avant de nettoyer votre APR, éteignez l'ordinateur et déconnectez-le de l'APR, puis débranchez ce dernier de la prise de courant.
- Nettoyez votre APR à l'aide d'un chiffon doux humidifié à l'eau plutôt qu'avec un nettoyeur liquide ou un aérosol.
- Si votre APR ou votre ordinateur est mouillé ou endommagé, suivez les procédures décrites dans la section « Dépannage » du *Guide d'utilisation*. Si, après avoir suivi ces procédures, vous vous rendez compte que votre APR ou votre ordinateur ne fonctionne toujours pas correctement, contactez Dell. (Reportez-vous à la section « Aide et assistance », du *Guide d'utilisation* pour connaître le numéro à appeler.)

## Connexion de périphériques externes à l'APR





Les connecteurs d'E/S (entrée/sortie) situés à l'arrière de l'APR dupliquent les connecteurs principaux à l'arrière et sur le côté de votre ordinateur. Le tableau 2-1 présente les icônes de chaque connecteur à l'arrière du réplicateur et indique le type de périphérique externe pouvant être branché à chaque connecteur.

**Tableau 2-1. Connecteurs externes**

	L'adaptateur CA/CC fourni avec l'APR se connecte au connecteur d'adaptateur CA/CC.
	Un périphérique série, tel qu'une souris série, se connecte au connecteur série.
	Un microphone se connecte au connecteur de microphone.
	Un haut-parleur ou les écouteurs se connectent au connecteur de ligne de sortie.
	Un câble d'interface réseau se connecte au connecteur NIC.
	Un périphérique USB, tel qu'une souris USB, se connecte au connecteur USB.
	Une ligne téléphonique externe se connecte au connecteur de modem.

**Tableau 2-1. Connecteurs externes (suite)**

---

	Un moniteur externe se connecte au connecteur de moniteur.
	Un périphérique parallèle, tel qu'une imprimante, se connecte au connecteur parallèle.
	Une souris externe de style PS/2 (Personal System/2) se connecte au connecteur de souris PS/2.
	Un clavier externe de style PS/2 ou un pavé numérique externe se connecte au connecteur de clavier PS/2.
	Un lecteur externe de CD-ROM, DVD-ROM, CD-RW, Zip 250 ou de disquette se connecte au connecteur de la baie des périphériques externe.

---

Suivez les instructions ci-après pour connecter des périphériques externes à l'APR.

**AVIS : Le connecteur NIC et les deux connecteurs PS/2 situés à l'arrière de APR sont inversés (comme vous pouvez le voir en faisant face à l'arrière de l'APR). Avant de connecter les câbles, vérifiez que les broches des connecteurs sont correctement alignées pour éviter d'endommager les connecteurs.**

1. Reportez-vous à la figure 2-1 pour connecter des périphériques externes aux connecteurs appropriés à l'arrière de l'APR.



*REMARQUES : Si le connecteur du câble du périphérique externe possède des écrous, veillez à bien les serrer pour assurer une connexion correcte.*

*Pour connecter votre ordinateur à un périphérique SCSI, vous devez connecter une carte PC SCSI à votre ordinateur. Pour plus d'informations sur les cartes PC, consultez la section « Cartes PC » dans le guide d'utilisation en ligne de votre ordinateur Dell Latitude L400.*

**AVIS : Ne branchez pas une ligne téléphonique sur le connecteur NIC.**

Pour obtenir des informations détaillées sur l'utilisation des périphériques externes avec votre ordinateur, consultez la section « Utilisation de périphériques externes » de votre guide d'utilisation en ligne.

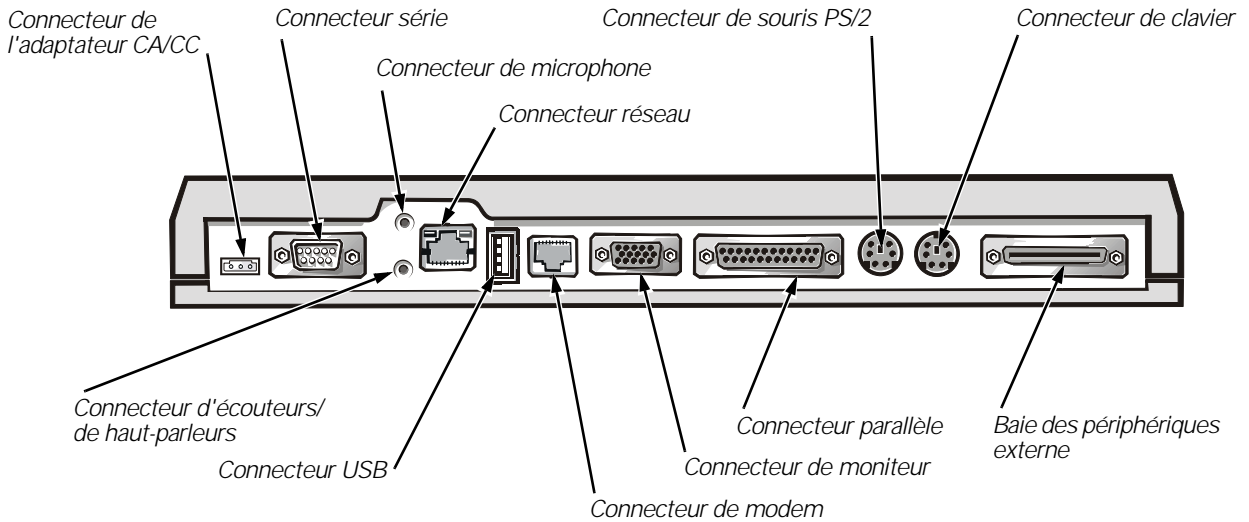

**Figure 2-1. Connexion de périphériques externes à l'APR**

2. Le cas échéant, connectez les périphériques externes à leurs sources d'alimentation.

## **Connexion de l'ordinateur à l'APR**

Suivez les instructions ci-après pour connecter votre ordinateur à l'APR.

1. Enregistrez votre travail et quittez tous les programmes d'application.
2. Arrêtez l'ordinateur.
3. Si cela n'est pas encore fait, connectez l'adaptateur CA/CC au connecteur situé sur l'APR (voir figure 2-1) et branchez le câble d'alimentation en CA au secteur.
4. Placez l'arrière de l'ordinateur sur la plate-forme APR en alignant les côtés de l'ordinateur entre les ailes de la plate-forme (voir figure 2-2).

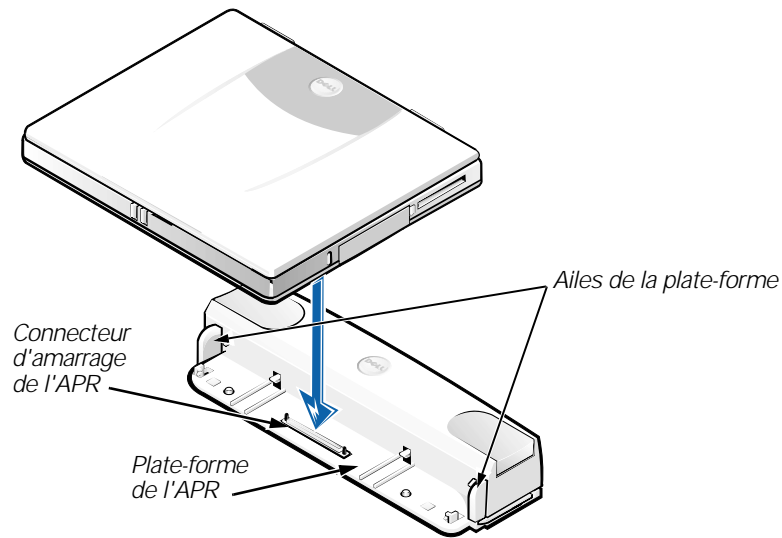

**Figure 2-2. Positionnement de l'ordinateur sur l'APR**

5. Abaissez soigneusement l'ordinateur dans la plate-forme de l'APR, comme illustré à la figure 2-2, jusqu'à ce que les connecteurs d'amarrage de l'APR et de l'ordinateur s'engagent.

Lorsqu'un clic se produit, l'ordinateur est verrouillé à l'APR et les connecteurs d'amarrage sont complètement insérés.

**AVIS : Si les périphériques externes connectés via l'APR ne fonctionnent pas correctement, assurez-vous que l'ordinateur et l'APR sont parfaitement connectés, en appuyant fermement aux deux angles de l'ordinateur les plus proches du connecteur d'amarrage de l'APR.**

6. Allumez l'ordinateur.

## **Déconnexion de l'ordinateur de l'APR**

Suivez la procédure ci-après pour déconnecter l'ordinateur de l'APR :

1. Enregistrez votre travail et quittez tous les programmes d'application.
2. Arrêtez l'ordinateur.
3. Appuyez simultanément sur les boutons de déblocage gauche et droit situés en haut du réplicateur, comme illustré à la figure 2-3, pour déconnecter l'ordinateur.



4. Soulevez l'ordinateur et éloignez-le de l'APR.

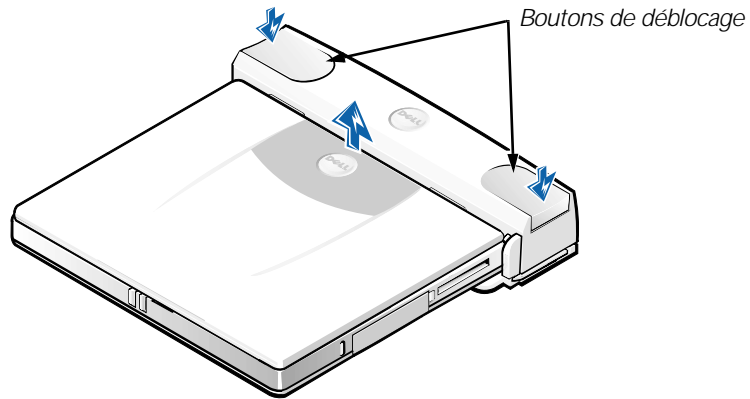

**Figure 2-3. Déconnexion de l'ordinateur de l'APR**

## Anneau de sécurité

L'anneau de sécurité empêche le retrait non autorisé de votre APR. Il pivote hors de l'APR, comme illustré à la figure 2-4. Un câble antivol passe autour d'un objet inamovible, puis dans l'anneau de sécurité de l'APR avant d'être verrouillé dans la fente pour câble de sécurité de l'ordinateur. Pour plus d'informations, consultez le *Guide d'utilisation de l'ordinateur Dell Latitude L400*.

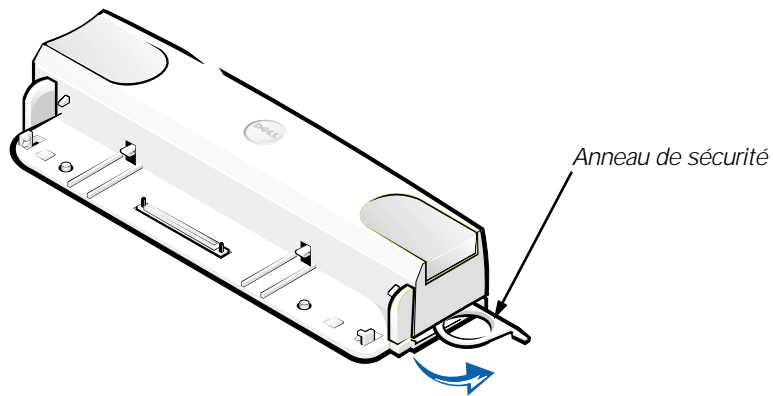

**Figure 2-4. Anneau de sécurité de l'APR**

# Caractéristiques techniques

Le tableau 2-2 répertorie les caractéristiques techniques de l'APR.

**Tableau 2-2. Caractéristiques techniques**

<b>Caractéristiques physiques</b>	
Hauteur . . . . .	38,25 mm (1,5 pouces)
Profondeur . . . . .	50,0 mm (2,0 pouces)
Largeur . . . . .	298,0 mm (11,7 pouces)
Poids . . . . .	389 g (0,86 livres)
<b>Connecteurs</b>	
Extension (pour connecter un ordinateur) . . . . .	Connecteur d'amarrage de l'APR
Série (DTE) . . . . .	Connecteur mâle à 9 broches
Parallèle . . . . .	Connecteur femelle à 25 trous
Clavier/pavé numérique PS/2 . . . . .	Connecteur de clavier externe à 6 trous
Souris PS/2 . . . . .	Connecteur de souris externe à 6 trous
LAN . . . . .	Connecteur RJ45
Modem . . . . .	Connecteur RJ11
Moniteur . . . . .	Connecteur femelle à 15 trous
Prises jack audio . . . . .	Microphone (entrée), une ligne de sortie audio
USB . . . . .	Connecteur mâle à 4 broches
Baie des périphériques externes . . . . .	Connecteur IDE/FDD à 68 broches
CC (entrée) . . . . .	Connecteur d'alimentation CC à trois broches
<b>Environnement</b>	
Température de fonctionnement . . . . .	5° à 35°C (41° à 95°F)
Température de stockage . . . . .	-20° à 60°C (-4° à 149°F)
Humidité relative de fonctionnement . . . . .	20 % à 80 % (sans condensation)
Humidité relative de stockage . . . . .	8 % à 90 % (sans condensation)

## Réglémentations

Les interférences électromagnétiques constituent des signaux ou émissions, dans un espace libre ou conduit par les cordons d'alimentation ou de signal, qui menacent le fonctionnement de la radionavigation, des services de sécurité ou qui dégradent sérieusement, obstruent ou interrompent régulièrement les services autorisés de communications radio. Les services de communications radio comprennent, entre autres, les diffusions commerciales AM/FM, la télévision, les services cellulaires, les systèmes de radar et de contrôle aérien, les radiomessageries et les services PCS (Personal Communication Services – services de communications personnelles). Ces services autorisés, tout comme des perturbateurs involontaires tels que des appareils numériques, y compris les systèmes informatiques, contribuent à l'environnement électromagnétique.

La compatibilité électromagnétique (EMC, ElectroMagnetic Compatibility) est la possibilité pour ces éléments d'équipement électronique de fonctionner ensemble correctement dans l'environnement électronique. Bien que ce système informatique ait été conçu pour être conforme aux limites de l'instance réglementaire des EMI, il n'y a aucune garantie concernant les interférences pouvant survenir dans une installation particulière. Si l'équipement crée des interférences avec les services de communications radio, ce qui peut être déterminé en l'allumant et l'éteignant, vous êtes encouragé à essayer de corriger les interférences en prenant une ou plusieurs des mesures ci-dessous.

- Changez l'orientation de l'antenne de réception.
- Changez la position de l'ordinateur par rapport au récepteur.
- Éloignez l'ordinateur du récepteur.
- Branchez l'ordinateur à une source d'alimentation différente de manière à ce que l'ordinateur et le récepteur soient sur des circuits de branchement différents.

Si nécessaire, consultez un agent du support technique de Dell ou un technicien expérimenté en radio/télévision pour des suggestions supplémentaires. Vous pouvez consulter le *FCC Interference Handbook, 1986 (Guide des Interférences FCC, 1986)*, pour vous aider. Vous pouvez vous le procurer à l'adresse postale suivante : U.S. Government Printing Office, Washington, DC 20402, Stock No. 004-000-00450-7, USA ou sur le site Internet à l'adresse suivante : **<http://www.fcc.gov/cib/Publications/tvibook.html>**.

Les systèmes informatiques Dell sont conçus, testés et classés selon l'environnement électromagnétique auquel ils sont destinés. Ces classifications de l'environnement électromagnétique font généralement référence aux définitions suivantes :

- La classe A concerne généralement les environnements industriels ou commerciaux.
- La classe B concerne généralement les environnements résidentiels.

Les équipements ITE (Information Technology Equipment – équipements de technologie de l'information), y compris les périphériques, les cartes d'extension, les imprimantes, les périphériques d'entrée/sortie (E/S), les moniteurs, etc., qui sont intégrés ou connectés au système devraient correspondre à la classification de l'environnement électromagnétique du système informatique.

**Remarque sur les câbles de signal blindés : N'utilisez que des câbles blindés pour connecter les périphériques aux dispositifs Dell, afin de réduire la possibilité d'interférence avec les services de communications radio. L'utilisation de câbles blindés permet de garantir que vous gardez la classification ECM appropriée pour l'environnement donné. Pour les imprimantes parallèles, un câble approprié peut être obtenu auprès de Dell. Si vous préférez, vous pouvez commander un câble auprès de Dell sur le site Internet <http://www.dell.com/products/dellware/index.htm>.**

La plupart des systèmes informatiques Dell sont conçus pour les environnements de la classe B. Pour déterminer la classification électromagnétique de votre système ou périphérique, consultez les sections suivantes spécifiques de chaque instance réglementaire. Chaque section fournit les spécifications EMC/EMI d'un pays ou des consignes de sécurité concernant un produit.

### ***Réglementation IC (Canada uniquement)***

La plupart des ordinateurs Dell (et autres appareils numériques Dell) sont classés par la norme Industry Canada (IC) Interference-Causing Equipment Standard (norme sur les équipements produisant des interférences) #3 (ICES-003) comme appareils numériques de classe B. Pour déterminer quelle classification s'applique (classe A ou B) à votre ordinateur (ou aux autres dispositifs numériques), examinez toutes les étiquettes d'enregistrement situées sur le dessous ou au dos de votre ordinateur (ou des autres appareils numériques). Une déclaration sous la forme « IC Class A ICES-003 » ou « IC Class B ICES-003 » doit apparaître sur l'une de ces étiquettes. Notez que la réglementation Industry Canada précise que tout changement ou modification non expressément approuvé par Dell peut annuler vos droits d'utilisation de cet équipement.

Cet appareil numérique de classe B (ou classe A, selon l'indication de l'étiquette d'enregistrement) répond aux normes Canadian Interference-Causing Equipment Regulations (normes sur les équipements produisant des interférences).

Cet appareil numérique de classe B (ou classe A, selon l'indication de l'étiquette d'enregistrement) respecte toutes les exigences de la Réglementation sur le Matériel Brouilleur du Canada.

### ***Réglementation concernant le modem***

L'étiquette IC fait foi que l'équipement est agréé. Cet agrément signifie que l'équipement répond aux normes de protection, de fonctionnement et de sécurité du réseau de communication, telles qu'elles figurent dans le ou les documents « Terminal Equipment Technical Requirements » appropriés. L'étiquette IC ne constitue pas une garantie que l'équipement satisfera l'utilisateur.

Avant d'installer cet équipement, l'utilisateur doit s'assurer qu'il n'est pas interdit de raccorder un tel équipement aux installations de l'opérateur téléphonique local. Cet équipement doit par ailleurs être installé en recourant à une méthode de connexion acceptable. L'utilisateur doit savoir que l'observation des conditions citées ci-dessus n'empêche pas obligatoirement une dégradation du service dans certaines situations.

Les réparations à effectuer sur un équipement agréé doivent être coordonnées par un représentant du fournisseur. Toute réparation ou modification de cet équipement effectuée par l'utilisateur, ou un mauvais fonctionnement de l'équipement peuvent amener l'opérateur téléphonique à demander le débranchement de cet équipement.

Pour sa propre protection, l'utilisateur doit s'assurer que les masses électriques du circuit électrique, des lignes téléphoniques et des tuyauteries en métal du local sont reliées. Cette précaution est particulièrement importante en zone rurale.

**AVIS : L'utilisateur ne doit pas tenter d'effectuer ces liaisons lui-même. Contactez pour cela un électricien agréé ou votre compagnie d'électricité.**



*REMARQUE : Le nombre équivalent de sonneries (REN) de chaque terminal connectable permet de calculer le nombre maximal de terminaux qui peuvent être connectés à une ligne téléphonique. En bout de ligne, le nombre d'équipements qui peuvent être connectés n'est pas directement limité, mais la somme des REN de ces équipements ne doit pas dépasser cinq.*

Le REN de votre modem interne, indiqué sur l'étiquette d'agrément IC située sous l'ordinateur, est de 0,6 B.

Les informations suivantes sont fournies en conformité avec la réglementation IC :

Dell Computer Corporation  
Warranty and Repair Service Center  
One Dell Way  
Round Rock, TX 78682 USA  
512-338-4400

### ***Garantie limitée pendant trois ans (Canada seulement)***

Dell Computer Corporation (« Dell ») fabrique ses produits à partir de pièces et de composants neufs ou quasiment neufs conformément aux pratiques industrielles standard. Dell garantit que ses produits sont exempts de tout défaut matériel et de fabrication. La garantie est valable pendant trois ans à compter de la date de facturation, comme indiqué ci-dessous.

Les éventuels dommages causés lors de l'expédition des produits chez le client sont couverts par cette garantie limitée. Par ailleurs, cette garantie limitée ne couvre pas les dommages résultant de causes externes : accidents, usage abusif ou à mauvais escient, problèmes d'alimentation électrique, interventions non autorisées par Dell, utilisation non conforme aux instructions du produit, non-exécution de l'entretien préventif exigé et problèmes dus à l'utilisation de pièces et de composants non fournis par Dell.

Cette garantie limitée ne s'applique pas aux articles des catégories suivantes : logiciels, périphériques (à l'exception de ceux spécifiquement indiqués), accessoires ou pièces ajoutés à un ordinateur Dell après son expédition par Dell, accessoires ou pièces ajoutés à un ordinateur Dell par le département d'intégration du système Dell, accessoires ou pièces qui ne sont pas installés à l'usine Dell ou produits DellWare. Les moniteurs, claviers et souris de marque Dell ou inclus dans la liste des prix standard de Dell sont couverts par cette garantie limitée ; tous les autres moniteurs, claviers et souris (y compris ceux vendus par le programme DellWare) ne sont pas couverts. Les batteries ne sont couvertes que pendant la première année de cette garantie limitée.

### *Garantie pendant la première année*

Lors de la première année à compter de la date de facturation, Dell répare ou remplace les produits qui sont retournés à l'usine Dell et qui sont couverts par cette garantie limitée. Pour obtenir le service de garantie, vous devez appeler le Support Technique Clientèle de Dell dans les limites de la période de garantie. Consultez la section « Contacter Dell » du guide en ligne de votre ordinateur afin de connaître le numéro de téléphone à contacter pour bénéficier d'une assistance client. Si une réparation sous garantie est nécessaire, Dell vous fournira un numéro d'autorisation de retour du matériel. Vous devez renvoyer les produits à Dell dans leur emballage d'origine ou un équivalent, payer d'avance les frais d'expédition et assurer l'envoi ou accepter les risques de perte ou de dommage pendant l'acheminement. Dell vous renverra le produit réparé ou le remplacera à ses frais si vous utilisez une adresse au Canada, le cas échéant. Les expéditions vers d'autres destinations sont payées à la réception.



*REMARQUE : Avant d'expédier les produits à Dell, sauvegardez les données des disques durs et de tout autre dispositif de stockage des produits. Retirez tous les supports amovibles, tels que les disquettes, les CD-ROM ou les cartes PC. Dell décline toute responsabilité en cas de perte de données ou de logiciels.*

Dell est propriétaire de toutes les pièces retirées des produits réparés. Dell utilise des pièces neuves ou remises en état provenant de différents fabricants pour les réparations sous garantie et pour la fabrication de produits de remplacement. Quand Dell répare ou remplace un produit, les termes de sa garantie ne sont pas étendus.

### *Garantie pendant la deuxième et la troisième année*

Pendant la deuxième et la troisième année de cette garantie limitée, Dell fournit, sur une base d'échange et en conformité avec la règle sur les retours de Dell effective à la date de l'échange, des pièces de rechange pour les produits matériels Dell couverts par cette garantie limitée, quand une pièce doit être remplacée. Vous devez indiquer chaque panne de matériel au Support Technique Clientèle de Dell afin que Dell convienne de la nécessité du remplacement de la pièce et expédie la pièce de rechange. Dell expédie les pièces (à ses frais) si vous utilisez une adresse au Canada, le cas échéant. Les expéditions vers d'autres destinations sont payées à la réception. Dell inclut un emballage d'expédition prépayé avec chaque pièce de rechange, afin que vous renvoyiez la pièce remplacée à Dell. Les pièces de rechange sont neuves ou remises en état. Dell peut fournir des pièces de rechange provenant de fabricants divers. Les conditions de garantie pour une pièce de rechange sont celles qui s'appliquent encore pour la garantie limitée.

Toute pièce de rechange dont l'équivalent défectueux et remplacé n'ayant pas été renvoyé à Dell devra être payée. La procédure de retour des pièces défectueuses, ainsi que votre engagement à payer les pièces de rechange si vous ne réexpédiez pas les pièces défectueuses à Dell, sont conformes à la règle sur les retours effective à la date de l'échange.

Vous acceptez la pleine responsabilité pour votre logiciel et vos données. Dell n'a pas à vous indiquer ou à vous rappeler les procédures de sauvegarde et les autres procédures appropriées.

### *Conditions générales*

DELL N'ACCORDE AUCUNE GARANTIE OU CONDITION EXPRESSE AU-DELÀ DE CELLES MENTIONNÉES DANS LE PRÉSENT CONTRAT DE GARANTIE LIMITÉE. DELL DÉCLINE TOUTE AUTRE GARANTIE OU CONDITION EXPRESSE OU IMPLICITE, INCLUANT SANS RESTRICTION LES GARANTIES ET CONDITIONS IMPLICITES DE QUALITÉ OU D'ADAPTABILITÉ À UN USAGE PARTICULIER. CERTAINS ÉTATS (OU JURIDICTIONS) NE RECONNAISSENT PAS DE RESTRICTION POUR LES GARANTIES OU CONDITIONS IMPLICITES, AUQUEL CAS LA RESTRICTION PRÉCÉDENTE PEUT NE PAS S'APPLIQUER.

LA RESPONSABILITÉ DE DELL POUR LE FONCTIONNEMENT DÉFECTUEUX ET LES DÉFAUTS DU MATÉRIEL EST LIMITÉE À LA RÉPARATION OU AU REMPLACEMENT COMME INDIQUÉ DANS CE CONTRAT DE GARANTIE LIMITÉE. CES GARANTIES VOUS DONNENT DES DROITS LÉGAUX SPÉCIFIQUES, AUXQUELS PEUVENT S'AJOUTER D'AUTRES DROITS, QUI VARIENT AU CAS PAR CAS (OU SELON LA JURIDICTION).

DELL DÉCLINE TOUTE RESPONSABILITÉ, AU-DELÀ DES RECOURS INDIQUÉS DANS CETTE DÉCLARATION DE GARANTIE LIMITÉE, POUR LES DOMMAGES ACCIDENTELS OU INDUITS, Y COMPRIS POUR LA NON-DISPONIBILITÉ D'UN PRODUIT OU POUR LA PERTE DE DONNÉES OU DE LOGICIEL, ET CE SANS RESTRICTION.

CERTAINS ÉTATS (OU JURIDICTIONS) NE RECONNAISSENT PAS D'EXCLUSION OU DE RESTRICTION SUR LES DOMMAGES SECONDAIRES OU INDUITS, AUQUEL CAS L'EXCLUSION OU LES RESTRICTIONS PRÉCÉDENTES PEUVENT NE PAS S'APPLIQUER.

Ces conditions s'appliquent uniquement à la garantie limitée pendant trois ans de Dell. Pour les réserves sur tout contrat de service couvrant votre ordinateur, reportez-vous à votre facture ou au contrat de service séparé que vous recevrez.

Si Dell choisit de remplacer un ordinateur ou un composant, l'échange se fera en conformité avec la règle sur les retours de Dell effective à la date de l'échange. Dans tous les cas où Dell délivre un numéro d'autorisation de renvoi du matériel, Dell doit recevoir le(s) produit(s) avant l'expiration de la période de garantie pour que la (les) réparation(s) puisse(nt) être couverte(s) par la garantie limitée.



*REMARQUE : Si vous choisissez l'une des options de garantie et de service disponibles au lieu de la garantie limitée standard de trois ans décrite ci-dessus, cette option sera indiquée sur votre facture.*

## **Règle de renvoi « Satisfait ou remboursé » (États-Unis et Canada seulement)**

En qualité de client et utilisateur final ayant acheté de nouveaux produits directement à une société Dell, vous êtes en droit de les retourner à Dell dans un délai de 30 jours à compter de la date de facturation pour un remboursement ou un avoir équivalent au prix d'achat. En qualité de client et utilisateur final ayant acheté des produits recyclés à une société Dell, vous êtes en droit de les retourner dans un délai de 14 jours à compter de la date de facturation pour un remboursement ou un avoir équivalent au prix d'achat. Dans un cas comme dans l'autre, le remboursement ou l'avoir n'inclut pas les frais de livraison et d'emballage indiqués sur votre facture. Si vous avez acheté nos produits en tant que société liée à Dell par un contrat écrit, les termes stipulés dans ce contrat au sujet du retour des produits peuvent différer de ceux spécifiés par la règle de retour.

Pour retourner les produits, vous devez appeler le Service Clientèle de Dell qui vous fournira un numéro d'autorisation de retour pour crédit. Consultez la section « Contacter Dell » du guide en ligne de votre ordinateur afin de connaître le numéro de téléphone à contacter pour bénéficier d'une assistance client. Afin d'accélérer la procédure de remboursement ou d'avoir, Dell attend que vous lui renvoyiez les produits dans leur emballage d'origine dans les cinq jours suivant l'attribution d'un numéro d'autorisation de retour pour crédit. Vous devez également payer d'avance les frais d'expédition et assurer l'envoi, ou accepter les risques de perte ou de dommage pendant l'acheminement. Vous ne pouvez renvoyer le logiciel pour un remboursement ou un avoir que si l'emballage scellé contenant les disquettes ou les CD n'a pas été ouvert. Les produits renvoyés doivent être comme neufs, et tous les guides, disquettes, CD, cordons d'alimentation et autres accessoires compris avec le produit doivent être renvoyés avec lui. Les clients désirant renvoyer, pour remboursement ou avoir uniquement, un des logiciels d'application ou un système d'exploitation installé par Dell doivent retourner le système dans son intégralité, avec tous les supports et la documentation inclus dans la livraison d'origine.

Cette règle de renvoi « Satisfait ou remboursé » ne s'applique pas aux produits DellWare, qui peuvent être retournés selon la règle de renvoi de DellWare actuellement en vigueur. En outre, les éléments recyclés achetés à la Vente de Pièces Détachées Dell au Canada ne peuvent être retournés.



Dell™ Latitude™ L400 Advanced Port Replicator

# GUIA DO USUÁRIO

[www.dell.com](http://www.dell.com)  
[support.dell.com](http://support.dell.com)



## **Notas, Avisos e Cuidados**

Neste manual, os blocos de texto podem estar acompanhados por um ícone e impressos em negrito ou itálico. Esses blocos são observações, avisos e advertências, utilizados desta forma:



*NOTA: Uma NOTA indica informações importantes que o ajudam a usar melhor o sistema do computador.*

**AVISO: Um AVISO informa sobre um dano potencial no hardware ou perda de dados e ensina a evitar o problema.**



**CUIDADO: Um CUIDADO indica a possibilidade de danos físicos, informando como evitar o problema.**

---

**As informações contidas neste documento estão sujeitas a alterações sem aviso prévio.  
© 1999-2001 Dell Computer Corporation. Todos os direitos reservados.**

É proibida a reprodução sem permissão por escrito da Dell Computer Corporation.

Marcas comerciais utilizadas neste texto: *Dell*, o logotipo da *DELL*, *Latitude* e *DellWare* são marcas comerciais da Dell Computer Corporation.

Outros nomes e outras marcas comerciais podem ser usados neste documento como uma referência às entidades que reivindicam as marcas ou aos nomes de seus produtos. A Dell renuncia ao direito de qualquer participação em nomes e marcas comerciais que não sejam de sua propriedade.



# **Dell™ Latitude™ L400**

## **Advanced Port Replicator**

### **Guia do Usuário**

O Dell Latitude L400 Advanced Port Replicator (APR) integra o seu computador Dell Latitude L400 de forma rápida e fácil a um ambiente da área de trabalho. Use as instruções neste documento para conectar dispositivos externos e o computador ao APR.

## **Instruções de Segurança**

Observe as instruções a seguir para evitar danos ao APR e à sua própria segurança:

- Não tente consertar o APR por conta própria. Sempre siga exatamente as instruções de instalação.
- Certifique-se de que nada esteja sobre o cabo de força do adaptador CA e de que esse cabo não fique exposto em locais onde se possa esbarrar ou pisar nele.
- O adaptador CA deve estar em uma área ventilada como, por exemplo, sobre a mesa ou no chão. Não cubra esse adaptador com papéis nem nada que reduza a ventilação. Não use o adaptador CA dentro de uma caixa.
- Não utilize o APR em um ambiente úmido, como próximo a banheiras, pias ou piscinas, ou qualquer local molhado em geral.
- Não introduza objetos em passagens ou aberturas de ar do APR para evitar incêndios ou choques elétricos e danificar os componentes internos.
- Use somente o adaptador CA aprovado para uso com este APR, conforme indicado neste documento. O uso de outro tipo de adaptador CA pode provocar incêndio ou explosão.

- Antes de conectar o APR a uma fonte de energia, verifique se a voltagem do adaptador CA corresponde à da fonte de energia disponível:
  - 115 volts (V)/60 hertz (Hz) em grande parte da América do Norte e do Sul e em alguns países do Extremo Oriente, como a Coréia do Sul e Taiwan
  - 100 V/50 Hz no leste do Japão e 100 V/60 Hz no oeste
  - 230 V/50 Hz em grande parte da Europa, Oriente Médio e Extremo Oriente
- Para evitar choque elétrico, conecte o adaptador CA e os cabos de força dos periféricos às fontes de energia aterradas corretamente. Esses cabos estão equipados com plugues de três pinos para assegurar o aterramento correto. Não use plugues adaptadores nem remova o pino de aterramento de um cabo. Se precisar de um cabo de extensão, use um cabo de três fios com os plugues aterrados corretamente.
- Se você usar um cabo de extensão com o adaptador CA, certifique-se de que a amperagem total dos aparelhos conectados ao cabo de extensão não ultrapasse a do próprio cabo.
- Para remover a força do APR, desligue o computador e desconecte o adaptador CA da tomada elétrica.
- Se o computador tiver um modem (Placa de PC) integrado ou opcional, o cabo utilizado com o modem deve ser fabricado com um tamanho de fio mínimo de 26 AWG (American wire gauge) e um plugue modular RJ-11 compatível com a FCC.
- Desconecte o cabo de modem durante tempestades magnéticas para evitar o risco remoto de choque elétrico provocado por emissão de raios através da linha telefônica.
- Para evitar o risco potencial de choque elétrico, não conecte ou desconecte cabos, nem faça manutenção ou reconfiguração deste produto durante tempestades magnéticas.
- Ao instalar o APR, coloque-o sobre uma superfície plana.
- Proteja o APR contra os riscos ambientais, como sujeira, poeira, alimentos, líquidos, picos de temperaturas e superexposição ao sol.
- Se o APR for submetido a variações bruscas de temperatura ou umidade (durante o transporte, por exemplo), talvez se forme uma condensação sobre ou dentro do computador. Para não danificar o APR, deixe a umidade evaporar antes de usar o computador.







**AVISO: Ao transportar o APR de condições de baixa temperatura para um ambiente mais quente ou de condições de alta temperatura para um ambiente mais frio, aguarde o APR se adaptar à temperatura ambiente antes de ligá-lo.**

- Ao desconectar um cabo, retire o conector ou o respectivo loop de alívio de tensão, não o cabo propriamente dito. Ao remover o conector, mantenha-o alinhado para não danificar os pinos. Além disso, antes de conectar um cabo, certifique-se de que ambos os conectores estejam orientados e alinhados corretamente.
- Ajuste o APR com cuidado.
- Antes de limpar o APR, desligue o computador e desconecte-o do APR. A seguir, desconecte o APR de sua fonte de alimentação.
- Limpe o APR com um tecido leve, umedecido em água, em vez de em detergentes líquidos ou em limpadores em aerossol.
- Se o APR ou o computador for molhado ou danificado, siga os procedimentos descritos em "Solucionando Problemas do Computador" no *Guia do Usuário*. Se, após seguir esses procedimentos, o APR ou computador não funcionar corretamente, entre em contato com a Dell. (Consulte "Obtendo Ajuda" no *Guia do Usuário* para obter o número de telefone correto.)

## Conectando Dispositivos Externos ao APR







Os conectores de entrada/saída (E/S) na parte traseira do APR duplicam os conectores primários nas partes lateral e traseira do computador. A Tabela 3-1 mostra os ícones de cada conector na parte traseira do APR e indica o tipo de dispositivo(s) externo(s) que pode(m) ser conectado(s) a cada conector.

**Tabela 3-3. Conectores Externos**

	O adaptador CA fornecido com o APR é conectado ao conector do adaptador CA.
	Um dispositivo serial, como um mouse, é conectado ao conector serial.
	Um microfone é conectado ao conector de microfone.
	Um alto-falante ou fones de ouvido são conectados ao conector de saída.
	Um cabo de interface de rede é conectado ao conector NIC.
	Um dispositivo USB, como um mouse USB, é conectado ao conector USB.

**Tabela 3-3. Conectores Externos (continuação)**

---

	Uma linha telefônica externa é conectada ao conector de modem.
	Um monitor externo é conectado ao conector de monitor.
	Um dispositivo paralelo, como uma impressora, é conectado ao conector paralelo.
	Um mouse externo compatível com Personal System/2 (PS/2) é conectado ao conector de mouse PS/2.
	Um teclado externo compatível com PS/2 ou um teclado numérico externo é conectado ao conector de teclado PS/2.
	Uma unidade externa de CD-ROM, DVD-ROM, CD-RW, Zip 250 ou disquete é conectada ao conector de compartimento externo de mídia.

---

Siga estas instruções para conectar qualquer dispositivo externo ao APR.

**AVISO: A NIC e os dois conectores PS/2 na parte de trás do APR são invertidos (vistos pela parte de trás do APR). Antes de conectar qualquer cabo, verifique se os pinos do conector estão alinhados corretamente para evitar danos aos conectores.**

1. Consulte a Figura 3-1 para conectar dispositivos externos aos conectores apropriados na parte de trás do APR.



*NOTAS: Se o conector de cabo do dispositivo externo tiver dois parafusos de aperto manual, aperte-os bem para obter qualidade de conexão.*

*Para conectar o computador a um dispositivo de interface para computador de pequeno porte (SCSI, small computer system interface), é necessário conectar um placa de PC SCSI ao computador. Consulte "Placas de PC" no Guia do Usuário do Dell Latitude L400 on-line para obter informações sobre utilização das Placas de PC.*

**AVISO: Não conecte uma linha telefônica ao conector de NIC.**

Para obter informações detalhadas sobre a utilização de dispositivos externos com o computador, consulte "Usando Dispositivos Externos" no Guia do Usuário on-line.

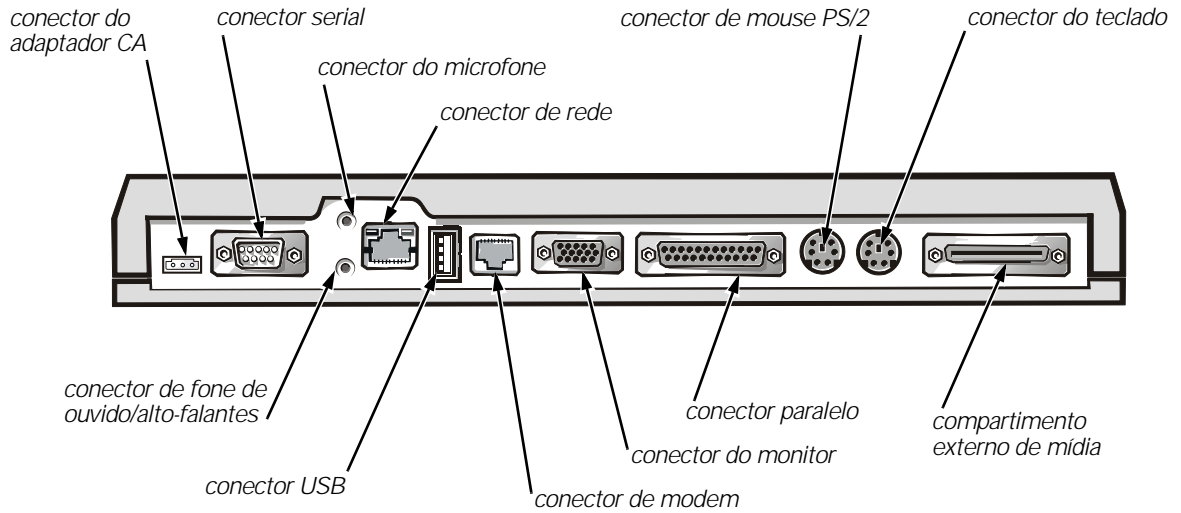

**Figura 3-7. Conectando Dispositivos Externos ao APR**

2. Conecte os dispositivos externos às fontes de energia, se aplicável.

## Conectando o Computador ao APR

Siga estas instruções para conectar o computador ao APR.

1. Salve todo o trabalho e feche todos os programas aplicativos.
2. Desligue o computador.
3. Se você ainda não o fez, conecte o adaptador CA ao conector no APR (consulte a Figura 3-1) e conecte o cabo de força CA a uma fonte de energia CA.
4. Coloque a parte de trás do computador sobre a plataforma APR, alinhando as laterais do computador entre os braços da plataforma (consulte a Figura 3-2).

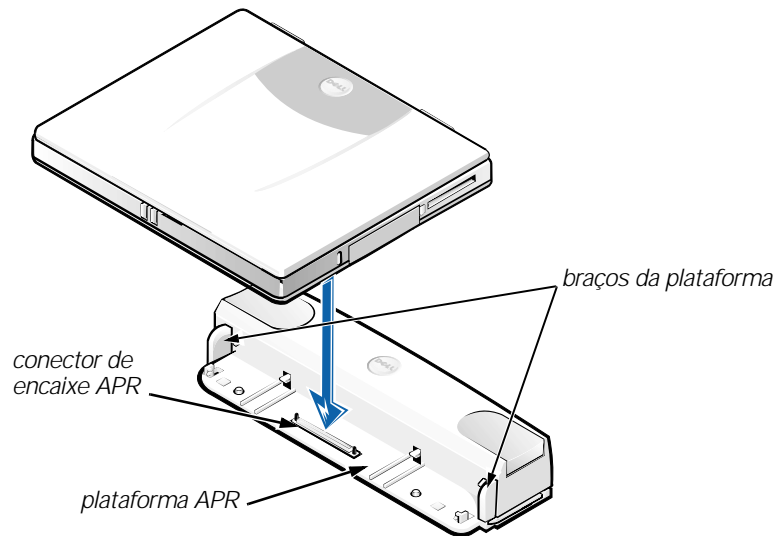

**Figura 3-8. Posicionando o Computador no APR**

5. Coloque o computador cuidadosamente na plataforma APR, conforme mostrado na Figura 3-2, até que o APR se prenda ao conector de encaixe do computador.

Quando ouvir ou sentir um clique, o computador estará travado ao APR e os conectores de encaixe estarão totalmente presos.

**AVISO: Se os dispositivos externos que estiverem conectados pelo APR não estiverem funcionando, verifique se o computador e o APR estão conectados corretamente pressionando para baixo com firmeza os dois cantos do computador mais próximos do conector de encaixe APR.**

6. Ligue o computador.



## ***Desconectando o Computador do APR***

Siga estes procedimentos para desconectar o computador do APR:

1. Salve todo o trabalho e feche todos os programas aplicativos.
2. Desligue o computador.
3. Ao mesmo tempo, pressione os botões de liberação esquerdo e direito na parte superior do replicador, conforme mostrado na Figura 3-3, para desencaixar o computador.
4. Levante o computador e retire-o do APR.

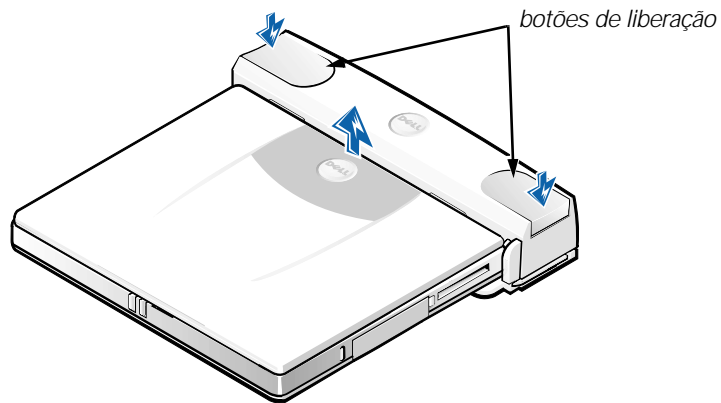

***Figura 3-9. Desconectando o Computador do APR***

## **Bloqueio de Segurança**

O bloqueio de segurança evita a remoção não autorizada do APR. O bloqueio de segurança sai do APR, conforme mostrado na Figura 3-4. Um dispositivo de cabo contra roubo é amarrado em um objeto fixo, passado pelo bloqueio de segurança no APR e, em seguida, travado no encaixe do cabo de segurança do computador. Para obter mais informações, consulte o *Guia do Usuário do Dell Latitude L400*.

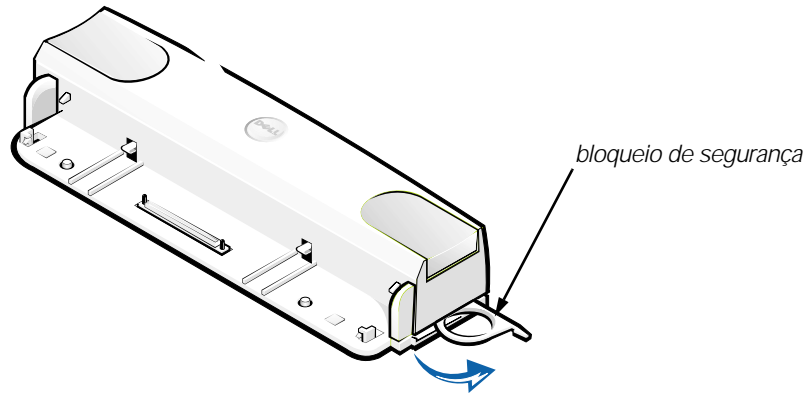

**Figura 3-10. Bloqueio de segurança do APR**

# Especificações Técnicas

A Tabela 3-2 lista as especificações técnicas do APR.

**Tabela 3-4. Especificações Técnicas**

<b>Físicas</b>	
Altura . . . . .	38,25 mm (3,81 cm)
Profundidade . . . . .	50,0 mm (5,08 cm)
Largura . . . . .	298,0 mm (29,72 cm)
Peso . . . . .	389 g (0,39 kg)
<b>Conectores</b>	
Expansão (para conectar ao computador) . . . . .	conector de encaixe APR
Serial (DTE). . . . .	conector macho de 9 pinos
Paralela. . . . .	conector fêmea de 25 orifícios
Teclado/teclado numérico compatível com PS/2 . . . . .	conector de teclado externo de 6 orifícios
Mouse compatível com o PS/2 . . . . .	conector de mouse externo de 6 orifícios
LAN . . . . .	conector RJ45
Modem. . . . .	conector RJ11
Monitor. . . . .	conector fêmea de 15 orifícios
Tomadas de áudio . . . . .	entrada de microfone, áudio de saída
USB . . . . .	conectores de 4 pinos
Compartimento externo de mídia . . . . .	conector IDE/FDD de 68 pinos
DC interno . . . . .	conector de força CC de três pinos
<b>Ambiental</b>	
Temperatura operacional . . . . .	5° a 35°C (41° a 95°F)
Temperatura de armazenamento. . . . .	-20° a 60°C (-4° a 149°F)
Umidade relativa operacional . . . . .	20% a 80% (sem condensação)
Umidade relativa de armazenamento. . . . .	8% a 90% (sem condensação)

## **Avisos de Regulamentação**

Interferência Eletromagnética (EMI, Electromagnetic Interference) é qualquer sinal ou emissão, irradiada em espaço livre ou transmitida através de condutores de força ou de sinais, que coloque em risco o funcionamento de um serviço de navegação de rádio ou outro serviço de segurança, ou que prejudique seriamente, obstrua ou interrompa várias vezes um serviço licenciado de comunicação de rádio. Os serviços de comunicação de rádio incluem, mas não se limitam a, transmissão comercial AM/FM, televisão, serviços de celular, radar, controle de tráfego aéreo, pager e Serviços de Comunicação Pessoal (PCS, Personal Communication Services). Esses serviços licenciados, juntamente com radiadores involuntários como dispositivos digitais, incluindo computadores, contribuem para o ambiente eletromagnético.

Compatibilidade Eletromagnética (EMC, Electromagnetic Compatibility) é a capacidade que os itens de um equipamento eletrônico possuem de funcionar corretamente em conjunto no ambiente eletrônico. Embora esse computador tenha sido projetado e esteja em conformidade com os limites estabelecidos pelos órgãos de regulamentação para EMI, não há garantias de que não ocorrerá interferência em uma instalação específica. Se o equipamento causar interferência nos serviços de comunicação de rádio, o que pode ser determinado ao ligar e desligar o equipamento, experimente:

- Reorientar a antena receptora.
- Mudar o computador de lugar em relação ao receptor.
- Afastar o computador do receptor.
- Ligar o computador em outra tomada de modo que o computador e o receptor fiquem em circuitos derivados diferentes.

Se necessário, consulte um Representante do Suporte Técnico da Dell ou um profissional técnico experiente de rádio/televisão para obter outras sugestões. Talvez você ache útil o *FCC Interface Handbook, 1986*. Ele está disponível em U.S. Government Printing Office, Washington, DC 20402, Stock No. 004-000-00450-7 ou na World Wide Web, em <http://www.fcc.gov/cib/Publications/tvibook.html> (em inglês).

Os computadores da Dell são projetados, testados e classificados para um ambiente eletromagnético específico. Essas classificações de ambiente eletromagnético geralmente se referem às seguintes definições:

- Classe A para ambientes comerciais ou industriais.
- Classe B para ambientes residenciais.

Os equipamentos de tecnologia de informação (ITE, Information Technology Equipment), incluindo, entre outros, periféricos, placas de expansão, impressoras, dispositivos de entrada e saída (E/S) e monitores, que estão integrados ou conectados ao sistema, devem estar de acordo com a classificação de ambiente eletromagnético do computador.

**Aviso Sobre Cabos Blindados de Sinal: Use somente cabos blindados para conectar periféricos a qualquer dispositivo da Dell, a fim de reduzir a possibilidade de interferência em serviços de comunicação de rádio. O uso de cabos blindados garante que a classificação apropriada de EMC seja mantida para o ambiente específico. Para impressoras paralelas, há um cabo da Dell disponível. Se preferir, solicite um cabo da Dell na World Wide Web em <http://www.dell.com/products/dellware/index.htm>.**

A maioria dos computadores da Dell é classificada para ambientes de Classe B. Para determinar a classificação eletromagnética de um sistema ou um dispositivo, consulte as seções a seguir, específicas para cada órgão de regulamentação. Cada seção possui informações sobre a segurança de produtos ou sobre EMC/EMI, específicas de cada país.

## ***Garantia de Um Ano do Fabricante (Somente na América Latina e Caribe)***

### *Garantia*

A Dell Computer Corporation ("Dell") garante ao usuário final, de acordo com as disposições a seguir, que os produtos de hardware de sua fabricação, adquiridos pelo usuário final em uma empresa da Dell ou em um distribuidor autorizado na América Latina ou no Caribe, não apresentarão defeitos materiais, de fabricação e design que afetem o uso normal, durante um período de um ano a partir da data de compra. Os produtos com reclamações pertinentes serão, a critério do fabricante, consertados ou trocados às custas da própria Dell, que detém todas as peças removidas dos produtos consertados, e usa peças novas e recondicionadas de vários fabricantes ao executar os reparos da garantia e para criar os produtos sobressalentes.

### *Exclusões*

Esta Garantia não se aplica aos defeitos decorrentes de: instalação, uso ou manutenção incorreta ou inadequada; ações ou alterações feitas por terceiros não autorizados ou pelo usuário final; danos acidentais ou inadvertidos; ou desgaste natural.

### *Reclamações*

As reclamações devem ser efetuadas na América Latina ou no Caribe entrando-se em contato com o ponto de vendas da Dell, dentro do prazo de garantia. O usuário final deve fornecer sempre o comprovante da compra, indicando nome e endereço do vendedor, data da compra, modelo e número de série, nome e endereço do cliente, e todos os detalhes de configuração na ocasião do mau funcionamento, incluindo periféricos e softwares utilizados. Caso contrário, a Dell pode recusar a reclamação. Ao diagnosticar um defeito coberto por garantia, a Dell tomará as providências e pagará frete e seguro para e a partir da central de consertos/trocas. O usuário final deve certificar-se de que o produto defeituoso esteja disponível para coleta, na embalagem original ou equivalente, juntamente com os detalhes listados anteriormente e o número de devolução fornecido ao usuário final.

### *Limitação e Direitos Estatutários*

A Dell não faz outra garantia, seguro ou declaração correlata além do explicitamente declarado acima, e esta Garantia é concedida em substituição a todas as outras garantias, até as disposições permitidas por lei. Na ausência de legislação aplicável, esta Garantia será o único respaldo do usuário final contra a Dell ou qualquer uma de suas afiliadas, sendo que nem a Dell nem quaisquer de suas afiliadas serão responsáveis por perdas financeiras ou de contratos, ou por qualquer outra perda indireta ou resultante, decorrente de negligência, quebra de contrato ou ações semelhantes.

Esta Garantia não prejudica nem afeta os direitos estatutários obrigatórios do usuário final contra e/ou quaisquer direitos resultantes de outros contratos concluídos pelo usuário final junto à Dell e/ou qualquer outro vendedor.

Dell World Trade LP  
One Dell Way, Round Rock, TX 78682, USA

Dell Computadores do Brasil Ltda. (CNPJ No. 72.381.189/0001-10)/  
Dell Commercial do Brasil Ltda. (CNPJ No. 03 405 822/0001-40)  
Avenida Industrial Belgraf, 400  
92990-000 - Eldorado do Sul - RS - Brasil

Dell Computer de Chile Ltda  
Coyancura 2283, Piso 3 - Of. 302,  
Providencia, Santiago - Chile

Dell Computer de Colombia Corporation  
Carrera 7 #115-33 Oficina 603  
Bogota, Colombia

Dell Computer de Mexico SA de CV  
Rio Lerma #302 - 4 Piso  
Col. Cuauhtemoc, Mexico, D.F. 06500

Replicador de puertos avanzado (APR) para sistemas Dell™ Latitude™ L400

# GUÍA DEL USUARIO

[www.dell.com](http://www.dell.com)  
[support.dell.com](http://support.dell.com)



## **Notas, avisos y precauciones**

En esta guía, algún bloque de texto puede ir acompañado de un icono y puede estar impreso en negrita o en cursiva. Estos bloques de texto son notas, avisos y precauciones que se utilizan como se indica a continuación:



*NOTA: una NOTA proporciona información importante que le ayuda a utilizar el ordenador de la mejor manera posible.*

**AVISO: un AVISO indica un posible daño al hardware o la pérdida de datos y le explica cómo evitar el problema.**



**PRECAUCIÓN: una PRECAUCIÓN indica una posible lesión corporal y le explica cómo evitar el problema.**

---

**La información contenida en este documento puede modificarse sin aviso previo.  
© 1999-2001 Dell Computer Corporation. Reservados todos los derechos.**

Queda estrictamente prohibida la reproducción de este documento de cualquier manera sin la autorización por escrito de Dell Computer Corporation.

Marcas comerciales utilizadas en este texto: *Dell*, el logotipo de *DELL*, *Latitude* y *DellWare* son marcas comerciales de Dell Computer Corporation.

Este documento puede incluir otras marcas y nombres comerciales para referirse a las entidades que los poseen o a sus productos. Dell renuncia a cualquier interés sobre la propiedad de marcas y nombres comerciales que no sean los suyos.





# **Dell™ Latitude™ L400**

## **Replicador de puertos avanzado**

### **Guía del usuario**

El replicador de puertos avanzado (APR) para sistemas Dell Latitude L400 integra rápida y fácilmente el ordenador portátil en un entorno de escritorio. Utilice las instrucciones de este documento para conectar dispositivos externos y el ordenador al APR.

### ***Instrucciones de seguridad***

Aplique las siguientes pautas de seguridad para proteger el APR contra posibles daños y garantizar su propia seguridad personal:

- No intente reparar usted mismo el APR. Siga siempre las instrucciones de instalación con exactitud.
- Asegúrese de que no haya nada sobre el cable de alimentación del adaptador de corriente alterna y que éste no esté localizado donde se pueda pisar o sea fácil tropezar con él.
- Coloque el adaptador de CA en una zona ventilada, por ejemplo sobre un escritorio o en el suelo, al encender el APR. No cubra el adaptador de CA con papeles u otros elementos que puedan reducir la ventilación. No utilice el adaptador de CA dentro de un maletín de transporte.
- No utilice el APR en un entorno húmedo, por ejemplo, cerca del baño, el lavabo, el fregadero, la piscina o una superficie mojada.
- No introduzca objetos en las rejillas de ventilación o aberturas del APR, ya que podría ocasionar un incendio o una descarga eléctrica producidos por un cortocircuito en los componentes interiores.
- Utilice sólo el adaptador CA que se ha aprobado para ser utilizado con este APR tal como se indica en este documento. El uso de otro tipo de adaptador de CA podría implicar un riesgo de incendio o explosión.

- Antes de conectar el APR a una fuente de alimentación, asegúrese de que el tipo de voltaje del adaptador CA coincide con el de la fuente de alimentación disponible:
  - 115 V/60 hertzios (Hz) en la mayor parte de América del Norte y Sudamérica, así como en algunos países del Lejano Oriente (por ejemplo, Corea del Sur y Taiwán)
  - 100 V/50 Hz en el este de Japón y 100 V/60 Hz en el oeste
  - 230 V/50 Hz en la mayor parte de Europa, Oriente Medio y Lejano Oriente
- Para evitar una descarga eléctrica, enchufe el adaptador de CA y los cables de alimentación de los dispositivos periféricos a fuentes de alimentación con toma de tierra. Estos cables están equipados con enchufes de tres-bornes para garantizar la toma de tierra. No utilice enchufes adaptadores ni retire los bornes de toma de tierra de los cables. Si debe utilizar un cable alargador, utilice cable de tres hilos y enchufes con toma de tierra.
- Si utiliza un alargador para el adaptador de CA, asegúrese de que la cantidad total de amperios de los dispositivos enchufados al alargador no excedan la cantidad de amperios que éste puede soportar.
- Para eliminar la alimentación del APR, apague el ordenador y desconecte el adaptador de CA de la toma de corriente.
- Si el ordenador incluye un módem integrado u opcional (de tarjeta PC), el cable utilizado con el módem debe poseer un tamaño mínimo de 26 AWG (American wire gauge, calibre de alambre americano) y un enchufe modular RJ-11 que cumpla el estándar de la Comisión Federal de Comunicaciones (FCC, del inglés Federal Communications Commission).
- Desconecte el cable del módem durante las tormentas eléctricas para evitar el riesgo (poco probable) de una descarga eléctrica producida por los rayos través de la línea telefónica.
- Para evitar el peligro potencial de sufrir una descarga eléctrica, no conecte ni desconecte ningún cable ni realice el mantenimiento o la reconfiguración de este producto en el transcurso de una tormenta eléctrica.
- Cuando configure el APR para trabajar, colóquelo en una superficie plana.
- Proteja el APR de los peligros ambientales como la suciedad, el polvo, la comida, los líquidos, las temperaturas extremas y las sobreexposiciones a la luz solar.
- Cuando cambie el APR de un medio a otro, con rangos de temperatura o humedad muy distintos, se producirá condensación en el equipo o dentro de éste. Para evitar daños en el APR, deje que transcurra el tiempo suficiente para que se evapore el vaho antes de utilizar el ordenador.







**AVISO: cuando mueva el APR de temperaturas bajas a medios más cálidos o de temperaturas muy altas a medios más fríos, espere a que el APR se adapte a la temperatura de la habitación antes de encenderlo.**

- Cuando desconecte un cable, tire del conector o del protector, no tire directamente del cable. Cuando retire el conector, manténgalo alineado para evitar doblar las patas. Del mismo modo, antes de conectar un cable, asegúrese de que los dos conectores estén orientados y alineados correctamente.
- Manipule el APR con cuidado.
- Antes de limpiar el APR, apague el ordenador y desconéctelo del APR. Después desconecte el APR de su fuente de alimentación.
- Limpie el APR con un paño suave mojado en agua en vez de utilizar algún líquido limpiador o aerosol.
- Si su APR u ordenador se moja o queda dañado, siga los procedimientos descritos en la sección "Solución de problemas del ordenador" de la *Guía del usuario*. Si después de seguir estos procedimientos llega a la conclusión de que su APR u ordenador no funciona de manera adecuada, póngase en contacto con Dell. Consulte la sección "Obtención de ayuda" de la *Guía del usuario* para buscar el número de teléfono adecuado.

## Conexión de dispositivos externos al APR







Los conectores de entrada/salida (E/S) situados en la parte posterior del APR son iguales a los conectores primarios que se encuentran en la parte posterior y lateral del ordenador. La Tabla 4-1 muestra los iconos de cada uno de los conectores situados en la parte posterior del APR e indica el tipo de dispositivo externo que se puede conectar a cada conector.

**Tabla 4-5. Conectores externos**

	El adaptador de CA incluido con el APR se conecta al conector del adaptador de CA.
	Un dispositivo serie, como puede ser un ratón serie, se conecta al conector serie.
	Se conecta un micrófono al conector de micrófono.
	Se conectan los auriculares o altavoces al conector de salida.
	Un cable de interfaz de red se conecta al conector NIC.
	Un dispositivo USB, como puede ser un ratón USB, se conecta al conector USB.

**Tabla 4-5. Conectores externos (continuación)**

---

	Se conecta una línea telefónica al conector de módem.
	Se conecta un monitor externo al conector de monitor.
	Se conecta un dispositivo paralelo, como puede ser una impresora, al conector paralelo.
	Se conecta un ratón compatible con Personal System/2 (PS/2) al conector de ratón PS/2.
	Se conecta un teclado externo compatible con PS/2 o un teclado numérico externo al conector de teclado PS/2.
	Se conecta una unidad de CD-ROM, DVD-ROM, CD-RW, Zip 250 o una unidad de disquete al conector del compartimento para dispositivos externos.

---

Utilice las siguientes instrucciones para conectar dispositivos externos al APR.

**AVISO: el NIC y los dos conectores PS/2 de la parte posterior del APR están invertidos (si se ven de cara a la parte posterior del APR). Antes de conectar todos los cables, compruebe que las patas están alineadas correctamente para no dañar los conectores.**

1. Consulte la Figura 4-1 para conectar dispositivos externos a los conectores apropiados en la parte posterior del APR.



*NOTAS: si el conector del cable del dispositivo externo tiene tornillos de mariposa, asegúrese de apretarlos para que la conexión sea correcta.*

*Para conectar el ordenador a un dispositivo SCSI (Small Computer System Interface, interfaz para sistemas informáticos pequeños), debe conectar una tarjeta PC SCSI en el ordenador. Consulte "Tarjetas PC" en la Guía del usuario de Dell Latitude L400 en línea para obtener información acerca de la utilización de las tarjetas PC.*

**AVISO: no conecte una línea telefónica al conector NIC.**

Para obtener información detallada acerca del uso de los dispositivos externos con el ordenador, consulte la sección "Uso de los dispositivos externos" en la Guía del usuario en línea.

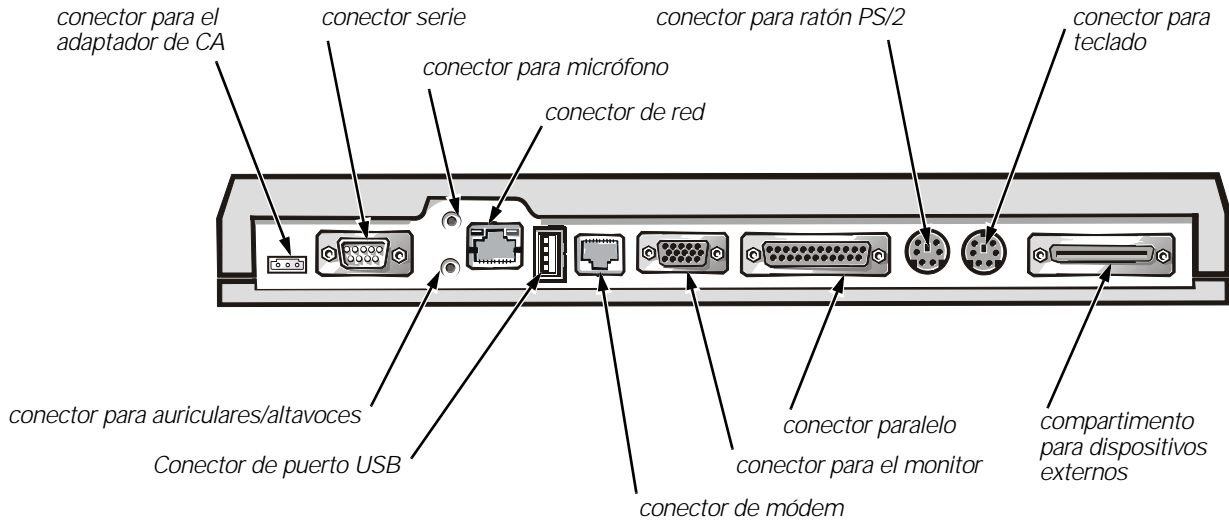

**Figura 4-11. Conexión de dispositivos externos al APR**

2. Conecte los dispositivos externos a las fuentes de alimentación, si es necesario.

## **Conexión del ordenador al APR**

Utilice las siguientes instrucciones para conectar el ordenador al APR.

1. Guarde todo el trabajo y salga de todos los programas.
2. Apague el ordenador.
3. Si aún no lo ha hecho, conecte el adaptador de CA al conector del APR (vea la Figura 4-1) y enchufe el cable de alimentación de CA a una fuente de alimentación de CA.

4. Sitúe la parte posterior del ordenador sobre la plataforma del APR, alineando los lados del ordenador entre los extremos de la plataforma (vea la Figura 4-2).

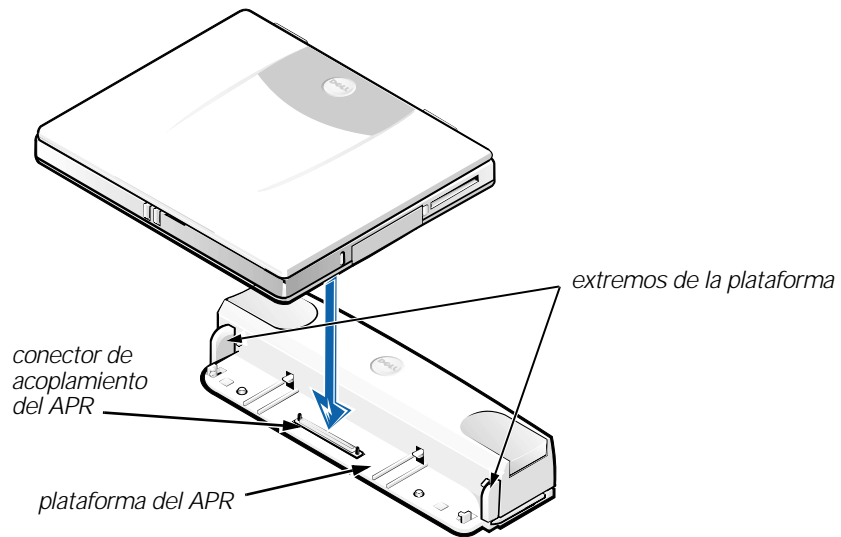

**Figura 4-12. Colocación del ordenador en el APR**

5. Baje cuidadosamente el ordenador a la plataforma del APR, como se muestra en la Figura 4-2, hasta que los conectores de acoplamiento del ordenador y el APR encajen.

Cuando oiga o sienta un clic, el ordenador estará asegurado al APR y los conectores de acoplamiento estarán completamente encajados.

**AVISO: si los dispositivos externos que están conectados por medio del APR no funcionan adecuadamente, asegúrese de que el ordenador y el APR están conectados correctamente presionando firmemente en las dos esquinas del ordenador más cercanas al conector de acoplamiento del APR.**

6. Encienda el ordenador.

## ***Desconexión del ordenador del APR***

Utilice el siguiente procedimiento para desconectar el ordenador del APR:

1. Guarde todo el trabajo y salga de todos los programas.
2. Apague el ordenador.
3. Al mismo tiempo, ejerza presión en los botones de liberación derecho e izquierdo de la parte superior del replicador, como se muestra en la Figura 4-3, para desacoplar el ordenador.
4. Levante el ordenador en dirección vertical y apártelo del APR.

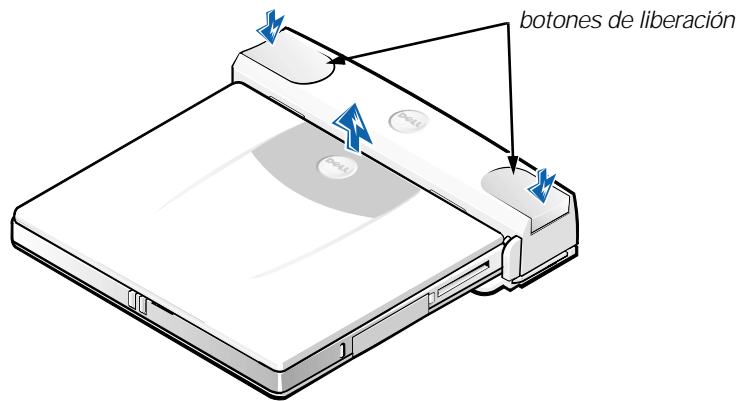

***Figura 4-13. Desconexión del ordenador del APR***

## Cierre de seguridad

El cierre de seguridad impide la separación no autorizada del APR. El cierre de seguridad cuelga de la parte externa del APR, como se muestra en la Figura 4-4. Hay un dispositivo de cable antirrobo, que pasa a través del cierre de seguridad del APR, enganchado alrededor de un objeto inamovible y bloqueado en la ranura del cable de seguridad del ordenador. Para obtener más información consulte la *Guía del usuario de Dell Latitude L400*.

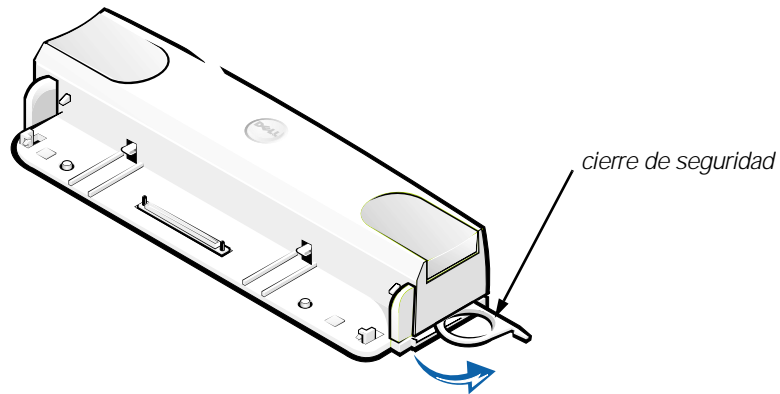

**Figura 4-14. Cierre de seguridad del APR**



# Especificaciones técnicas

La Tabla 4-2 muestra las especificaciones técnicas del APR.

**Tabla 4-6. Especificaciones técnicas**

<b>Dimensiones</b>	
Alto . . . . .	38,25 mm (3,81 cm)
Profundidad . . . . .	50,0 mm (5,08 cm)
Ancho . . . . .	298,0 mm (29,72 cm)
Peso . . . . .	389 g (0,86 libras)
<b>Conectores</b>	
Expansión (para conectar al ordenador) . . . . .	conector de acoplamiento del APR
Serie (DTE) . . . . .	conector macho de 9 patas
Paralelo . . . . .	conector hembra de 25 orificios
Teclado compatible con PS/2 o teclado numérico . . . . .	conector de teclado externo de 6 orificios
Ratón compatible PS/2 . . . . .	conector externo de ratón de 6 orificios
LAN . . . . .	conector RJ45
Módem . . . . .	conector RJ11
Monitor . . . . .	conector hembra de 15 orificios
Enchufes de audio . . . . .	micrófono de entrada, una salida de línea de audio
Bus serie universal (USB) . . . . .	conectores de 4 patas
Compartimento de medios externos . . . . .	conector IDE/FDD de 68 patas
CC en . . . . .	conector de alimentación CC de 3 patas
<b>Factores ambientales</b>	
Temperatura en funcionamiento . . . . .	de 5° a 35°C (de 41° a 95°F)
Temperatura en almacenamiento . . . . .	de -20° a 60°C (de -4° a 149°F)
Humedad relativa en funcionamiento . . . . .	del 20% al 80% (sin condensación)
Humedad relativa en almacenamiento . . . . .	del 8% al 90% (sin condensación)

## ***Avisos sobre regulación***

Una interferencia electromagnética (EMI, del inglés Electromagnetic Interference) es cualquier señal o emisión, radiada al espacio o conducida a través de un cable de alimentación o señal, que pone en peligro el funcionamiento de la navegación por radio u otro servicio de seguridad o degrada seriamente, obstruye o interrumpe de forma repetida un servicio de comunicaciones por radio autorizado. Los servicios de radiocomunicaciones incluyen, entre otros, emisoras comerciales de AM/FM, televisión, servicios de telefonía móvil, radar, control de tráfico aéreo, buscapersonas y servicios de comunicación personal (PCS, del inglés Personal Communication Services). Estos servicios autorizados, junto con emisores no intencionados como dispositivos digitales, incluidos los sistemas computacionales, contribuyen al entorno electromagnético.

La compatibilidad electromagnética (EMC, del inglés Electromagnetic Compatibility) es la capacidad de los componentes del equipo electrónico de funcionar correctamente juntos en el entorno electrónico. Aunque este sistema se ha diseñado y ajustado para cumplir con los límites de emisión electromagnética establecidos por la agencia reguladora, no hay ninguna garantía de que no ocurran interferencias en una instalación en particular. Si este equipo provoca interferencias con servicios de comunicaciones por radio, lo que se puede determinar encendiendo y apagando el equipo, pruebe a corregirlas mediante una o más de las siguientes medidas:

- Reoriente la antena de recepción.
- Reubique el equipo con respecto al receptor.
- Aparte el sistema del receptor.
- Enchufe el equipo a una toma diferente de forma que el equipo y el receptor se hallen en ramas diferentes del circuito.

Si es necesario, consulte a un representante de la Asistencia técnica de Dell o a un técnico experimentado de radio o televisión para obtener consejos adicionales. Un libro que puede serle de gran ayuda es el titulado *FCC Interference Handbook, 1986*. Está disponible a través de la oficina de publicaciones del gobierno de EE.UU.: U.S. Government Printing Office, Washington, DC 20402, Stock No. 004-000-00450-7, o en el sitio <http://www.fcc.gov/cib/Publications/tvibook.html> de la Red mundial.

Los sistemas computacionales Dell están diseñados, probados y clasificados según sus entornos electromagnéticos. Estas clasificaciones de entornos electromagnéticos se refieren generalmente a las siguientes definiciones armonizadas:

- Clase A es normalmente para entornos empresariales o industriales.
- Clase B es normalmente para entornos residenciales.

El equipo de tecnología de información (ITE, del inglés Information Technology Equipment), que incluye periféricos, tarjetas de expansión, impresoras, dispositivos de entrada/salida (E/S), monitores, etc., integrado en o conectado al sistema debe ajustarse a la clasificación del entorno electromagnético del sistema.

**Un aviso acerca de los cables de señal blindados: utilice únicamente cables blindados para conectar periféricos a cualquier dispositivo Dell para reducir la posibilidad de interferencias con servicios de comunicaciones de radio. La utilización de cables blindados garantiza que se mantiene la clasificación EMC adecuada para el entorno especificado. Para impresoras en paralelo, existe un cable disponible de Dell. Si lo prefiere, puede solicitar un cable de Dell en el sitio <http://www.dell.com/products/dellware/index.htm> de la Red mundial.**

La mayoría de los sistemas computacionales Dell están clasificados para entornos de Clase B. Para determinar la clasificación electromagnética de su sistema o dispositivo, consulte las siguientes secciones para cada agencia reguladora. Cada sección proporciona el EMI/EMC específico de cada país o información de seguridad del producto.

### ***Información para NOM (únicamente para México)***

La información siguiente se proporciona en el dispositivo o en los dispositivos descritos en este documento, en cumplimiento con los requisitos de la Norma Oficial Mexicana (NOM):

Exportador:	Dell Computer Corporation One Dell Way Round Rock, TX 78682
Importador:	Dell Computer de México, S.A. de C.V. Paseo de la Reforma 2620 - 11° Piso Col. Lomas Altas 11950 México, D.F.
Embarcar a:	Dell Computer de México, S.A. de C.V. al Cuidado de Kuehne & Nagel de México S. de R.I. Avenida Soles No. 55 Col. Peñon de los Baños 15520 México, D.F.
Voltaje de entrada de alimentación:	100-240 VAC
Frecuencia:	50-60 HZ
Consumo eléctrico:	1.5 A
Voltaje de salida:	19 VDC
Corriente de salida:	2.64 A

## ***Garantía de un año del fabricante para el usuario final (sólo para Latinoamérica y el área del Caribe)***

### ***Garantía***

Dell Computer Corporation ("Dell") garantiza al usuario final, de acuerdo con las provisiones siguientes, que los productos de hardware de marca, adquiridos por el usuario final a una empresa de Dell o a un distribuidor de Dell autorizado en Latinoamérica o el área del Caribe están libres de defectos en materiales, mano de obra y diseño que afecten a su utilización normal, por un período de un año desde la fecha original de la compra. Los productos sobre los que se hagan reclamaciones fundadas, serán reparados o reemplazados, a discreción de Dell, sin coste para el usuario. Dell será propietaria de todas las piezas extraídas de los productos reparados. Dell utiliza piezas nuevas y reacondicionadas de diversos fabricantes para efectuar reparaciones y fabricar componentes de repuesto.

### ***Exclusiones***

Esta garantía no se aplica a defectos que son resultado de: instalación, uso o mantenimiento incorrectos o inadecuados; acciones o modificaciones por parte de terceras personas no autorizadas o del usuario final; daño accidental o voluntario o deterioro normal por el uso.

### ***Hacer una reclamación***

En Latinoamérica o el área del Caribe, para hacer reclamaciones se debe contactar con un punto de venta de Dell dentro del período que cubra la garantía. El usuario final debe proporcionar siempre la prueba de compra, indicando el nombre del vendedor, fecha de la compra, modelo y número de serie, nombre y dirección del cliente y los detalles de síntomas y configuración del mal funcionamiento, incluyendo los periféricos y el software utilizados. De lo contrario, Dell puede rehusar la reclamación de la garantía. Si se diagnostica un defecto cubierto por la garantía, Dell efectuará las reparaciones y pagará el flete terrestre, así como el seguro de ida y vuelta desde el centro de reparación o sustitución de Dell. El usuario final deberá asegurarse de que el producto defectuoso esté disponible para su recogida adecuadamente acondicionado en el embalaje original u otro de las mismas características de protección junto con los detalles señalados anteriormente y el número de devolución suministrado por Dell al usuario final.

## *Derechos legales y limitación*

Dell no ofrece ninguna otra garantía ni realiza declaración equivalente que no sean las establecidas explícitamente más arriba y esta Garantía sustituye todas las otras garantías de cualquier manera, hasta el máximo permitido por la ley. En ausencia de legislación aplicable, esta Garantía será el único y exclusivo recurso del usuario final contra Dell o cualquiera de sus filiales, y ni Dell ni sus filiales se harán responsables de la pérdida de beneficios o contratos, ni de cualquier otro tipo de pérdida indirecta derivada de negligencia, incumplimiento del contrato o similar.

Esta garantía no supone menoscabo de, ni afecta a, los derechos legales preceptivos del usuario final frente a cualquier derecho derivado de otros contratos formalizados por el usuario final con Dell o cualquier otro vendedor.

Dell World Trade LP  
One Dell Way, Round Rock, TX 78682, USA

Dell Computadores do Brasil Ltda. (CNPJ No. 72.381.189/0001-10)/  
Dell Commercial do Brasil Ltda. (CNPJ No. 03 405 822/0001-40)  
Avenida Industrial Belgraf, 400  
92990-000 - Eldorado do Sul - RS - Brasil

Dell Computer de Chile Ltda  
Coyancura 2283, Piso 3 - Of.302,  
Providencia, Santiago - Chile

Dell Computer de Colombia Corporation  
Carrera 7 #115-33 Oficina 603  
Bogotá, Colombia

Dell Computer de México SA de CV  
Río Lerma #302 - 4 Piso  
Col. Cuauhtemoc, México, D.F. 06500







02C982 A00

P/N 2C982 Rev. A00



Printed in the U.S.A.

Imprimé aux U.S.A.  
Impresso nos E.U.A.  
Impreso en los EE.UU.

